

Leica MC1

Machine control software

Dozer

User manual (UM)

Version: 6.0

Released: 01/16/2024

Language: English (EN)

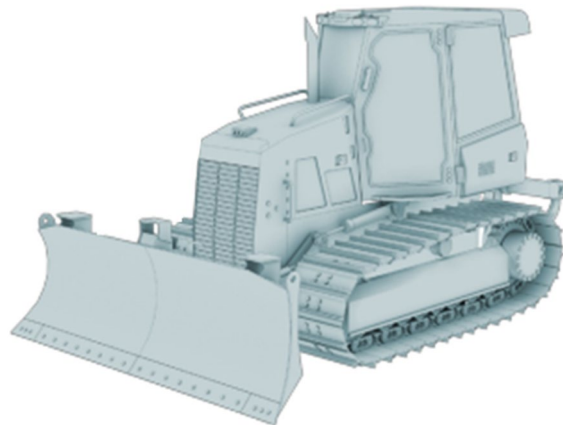

Manual type: User manual (UM)

ID: 929451

Version: 6.0

Language: English (EN)

Released: 01/16/2024

Made by: JEHA

Content: User workflows relating to the Leica MC1 machine control software for dozers.

Software: Leica MC1

Software version: 7.0

Machine type: Dozer

Brand: All

Model: All

Limitations: All rights reserved. No part of this manual may be reproduced in any form, or by any means, without prior written permission from LMC support.

Refer to the Leica MC1 "quick guide" for additional legal and safety related requirements.

Support: LMC support:

- Mail:
- Phone:

List of content

Your machine	4
Workflow 01: Identify your machine control solution	Error! Bookmark not defined.
Workflow 02: Define hydraulic performance settings (Gain).....	8
Workflow 03: Adjust height of an electric mast.....	9
Your 2D solution	11
Workflow 01: Switch from 3D to 2D mode	12
Workflow 02: Operate your machine with "cross slope" only	13
Workflow 03: Operate your machine with "CoPilot"	14
Workflow 04: Understanding CoPilot modes.....	15
Workflow 05: Laser setup considerations	17
Workflow 06: Setup a laser to create dual sloping surfaces	18
Workflow 07: Operate your machine with laser receiver + cross slope.....	19
Workflow 08: Operate your machine with "dual" laser receivers	20
Workflow 09: Configure sensor position without the MJB130x junction box.....	21
Your 3D solution	23
• Touch navigation	24
• GNSS basics.....	25
Workflow 01: Find your project and models.....	26
Workflow 02: Select and use references from run screen	28
Workflow 03: Offset a model reference.....	30
Workflow 04: Offset individual references	31
Workflow 05: Enter temporary mast height	33
Workflow 06: Change "height tool point"	34
Workflow 07: Change "side tool point".....	35
Workflow 08: Select and use "height reference"	36
Workflow 09: Select and use "side reference"	38
Workflow 10: Daily machine check-in	40
Workflow 11: Adjust blade wear.....	41
Workflow 12: Activate auto mode	42
Workflow 13: Create point logs.....	43
Workflow 14: Synchronize files	44
Appendix: List of "how to" videos	45

Introduction

In this user manual (UM) you will find essential workflows for you to gain success with your machine control solution.

All workflows evolve around MC1 (Software platform) **for dozer, and they cover** both 2D and 3D machine control solutions.

Every workflow begins with a short explanation of the task you may be facing, followed by a step-by-step procedure to help you finish your task successfully.

If you need more in-depth knowledge about any of the workflows, feel free to dive into the user reference manual (URM) for dozer. Alternatively, take a look at the "how to" videos available through QR coded links (See Appendix).

The first chapter in this manual helps you identify your solution. The next chapters focus on either a 2D or 3D solution.

Identify your solution and skip ahead to the chapter relevant to you.

Where can I learn more?

- User reference manual (URM) for dozer.
- "How to" videos for dozer (See Appendix).

1. Your machine

Workflows in this chapter focus on your machine as a whole, and are relevant for both 2D and 3D machine control solutions.



2D and 3D solution content:

- **Workflow 01:** Identify your machine control solution
- **Workflow 02:** Define hydraulic performance settings (Gain)
- **Workflow 03:** Adjust height on an electrical mast

Workflow 01: Identify your machine control solution

Find out if you have a 2D or 3D machine control solution installed on your machine. Once you know which solution you have to work with, you can skip ahead to the relevant chapter in this manual.

Step 1: Identify which machine control components you have installed on your machine.

Step 2: Identify the source of your position reference (Rotating laser, total station or satellite).

Step 3: Compare your hardware configuration with the overview on the following two pages:

- Do you have a 2D or 3D solution?

NOTE!

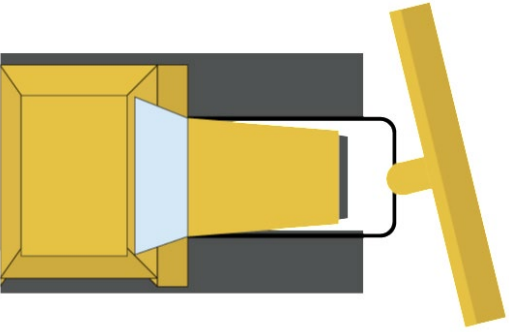

Blade rotation is **NOT** possible with the following configurations:

- CoPilot.
- Single laser.
- Single GNSS, total station, on-cab.

Blade rotation is **possible** with the following configurations:

- Dual laser.
- Dual GNSS.
- 6-way blade.

2D solution (Illustration)

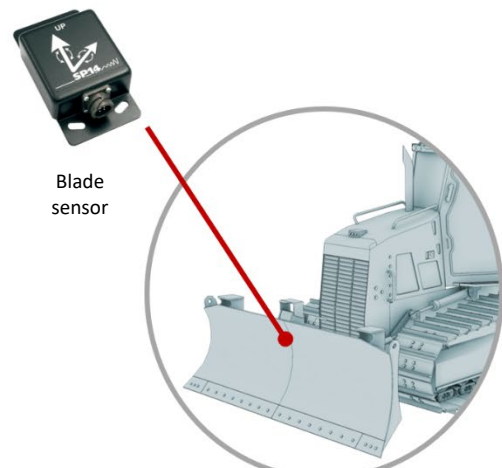
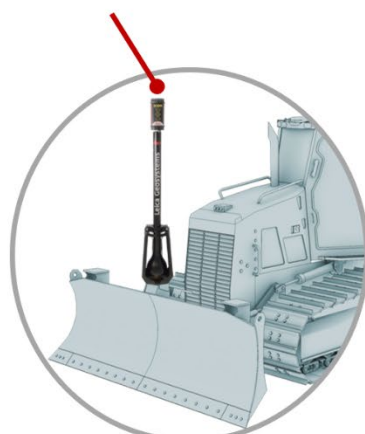
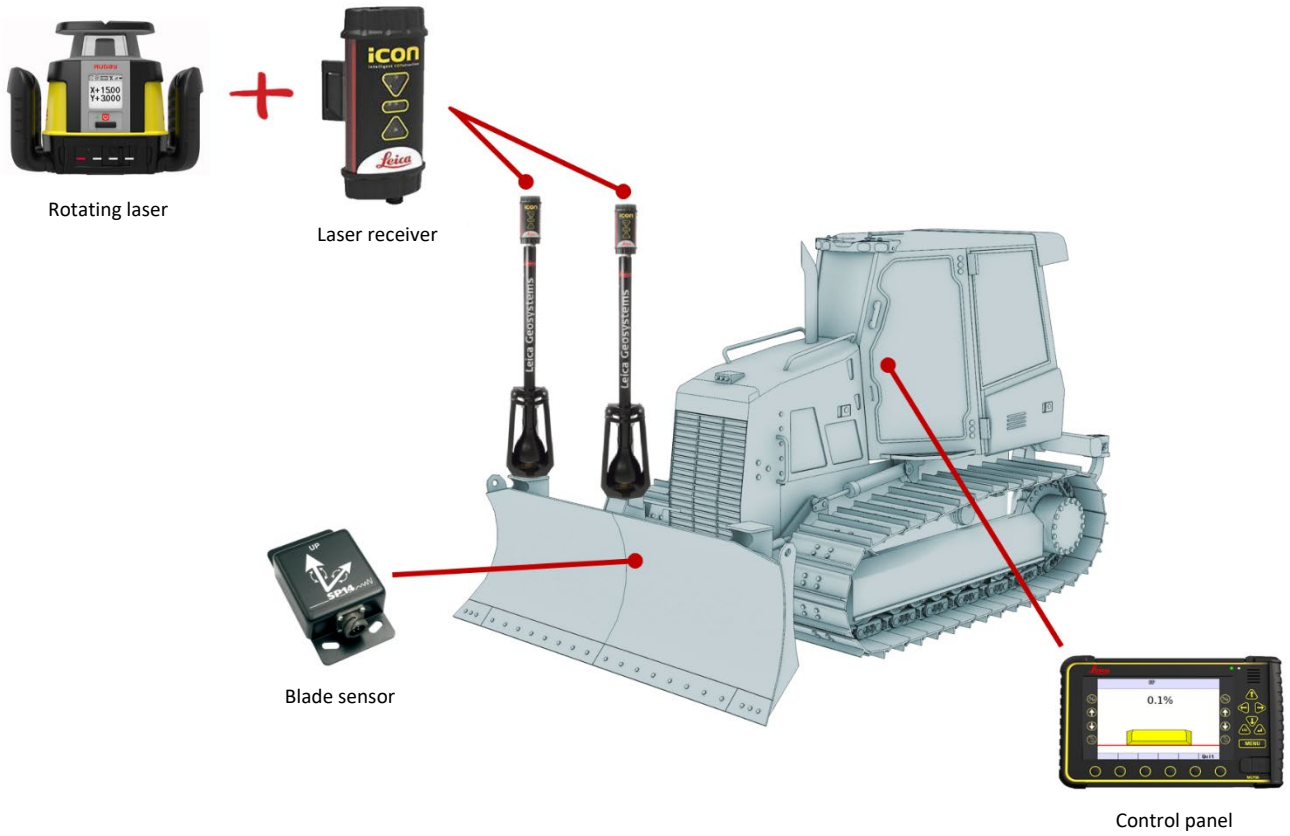

3D solution (Illustration)

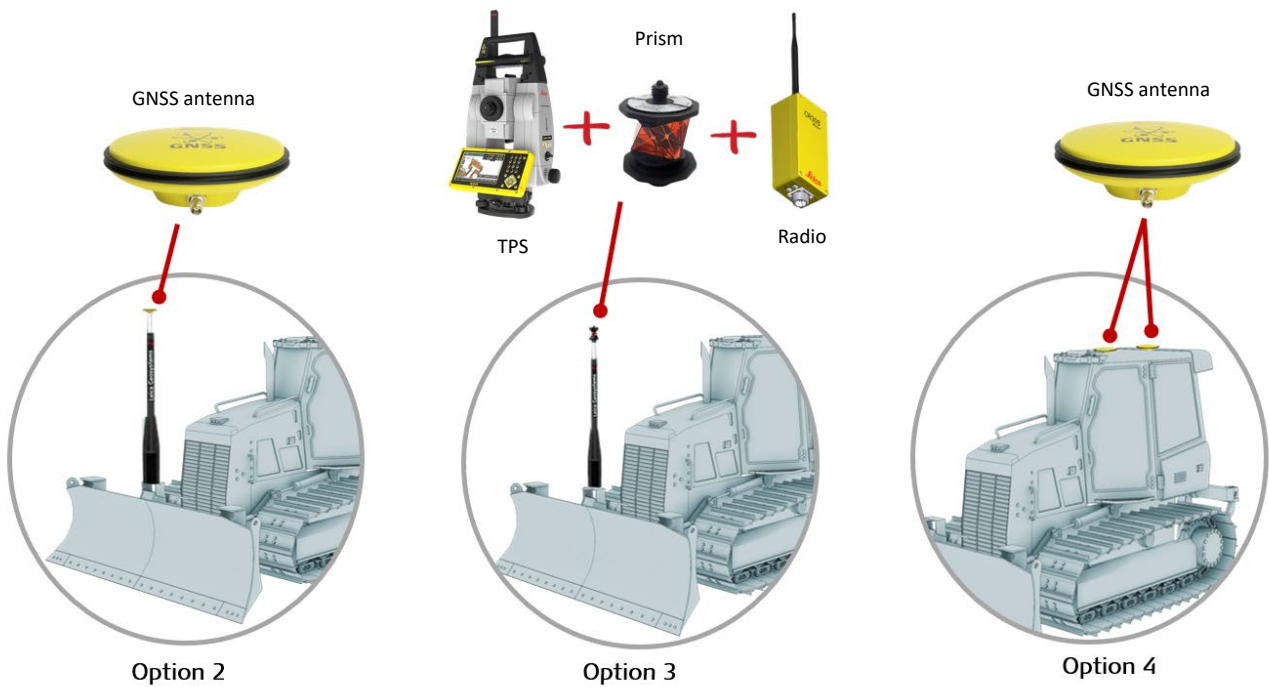
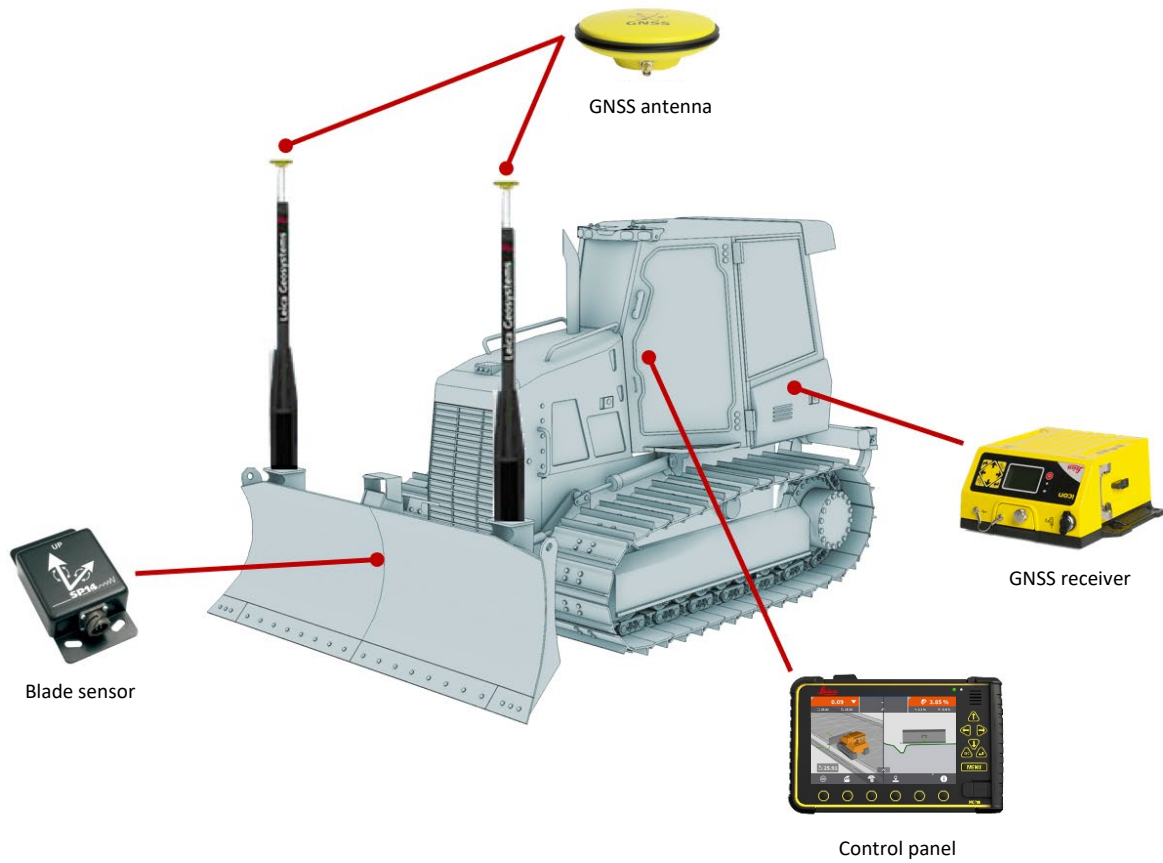

Workflow 02: Define hydraulic performance settings (Gain)

When working with different material types you may need to adjust speed of your machine hydraulics, to better accommodate how the system reacts to different weights of material (Sand compared to heavy organic soil). This is accomplished by adjusting "Gain". A different gain value can be assigned to each sensor. Only small adjustments are recommended. Please note that many other calibration parameters also affects performance.

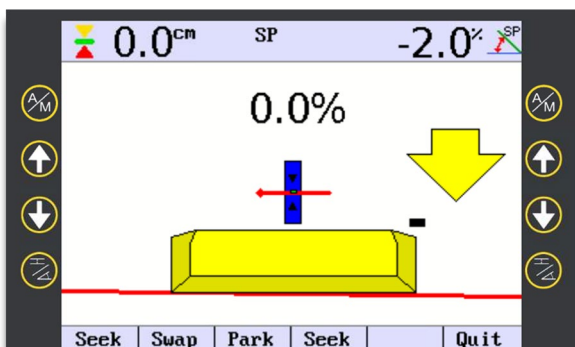

Step 1: Access 2D user interface (See 2D [Workflow 01](#)).

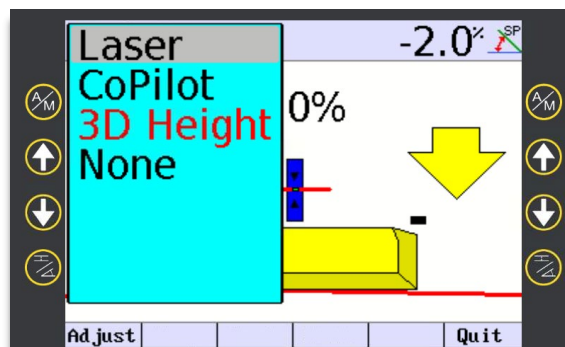

Step 2: Select "Configure" button and highlight desired sensor to adjust.

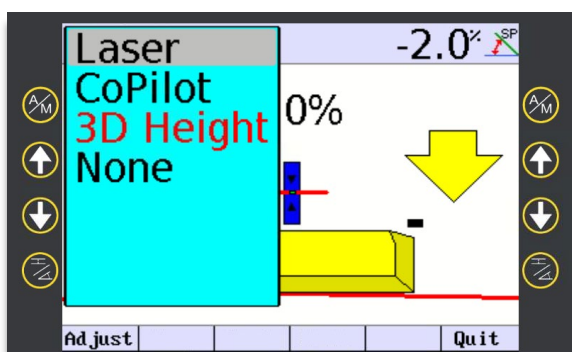

Step 3: Select "Adjust".

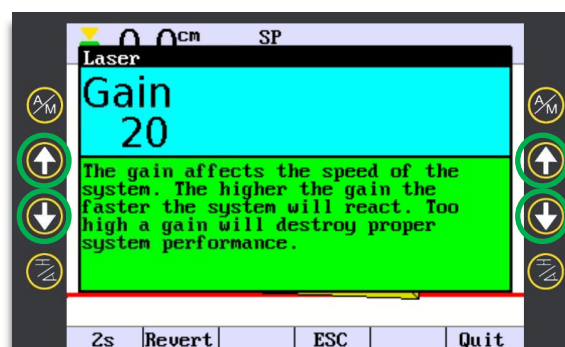

Step 4: Use up/down soft or hard keys to adjust gain value until hydraulics perform to satisfaction.

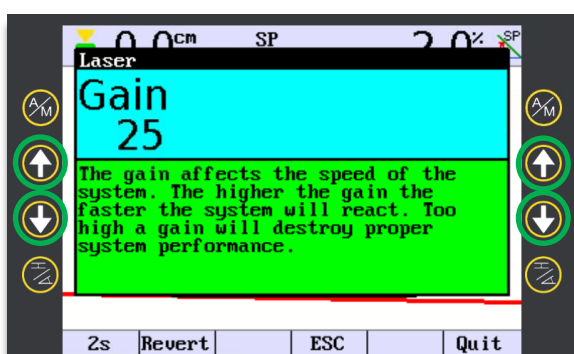

- **Tip:** Start by changing 10 steps. If too little, then do 10 more. If too much go 5 steps back. Continue this "halving" method until satisfaction.

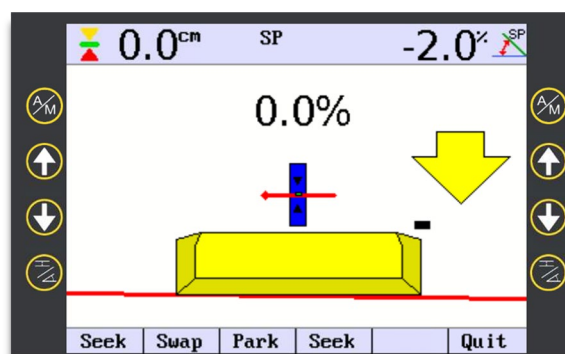

Step 5: Select "Menu" to apply changes and return to run screen.

Workflow 03: Adjust height of an electric mast

If you operate your machine with an electric mast in a TPS setup, you may need to adjust mast height. This workflow describes how to adjust the height in the 2D system.

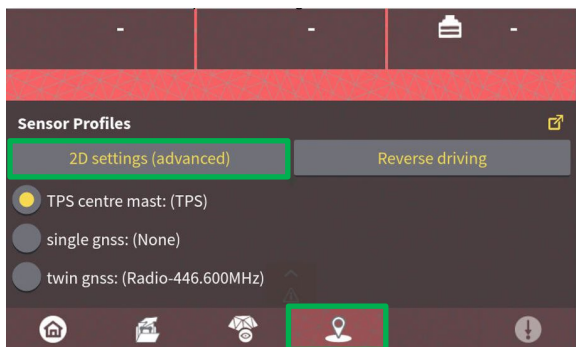

Step 1: Press the positioning icon to enter the 2D settings.

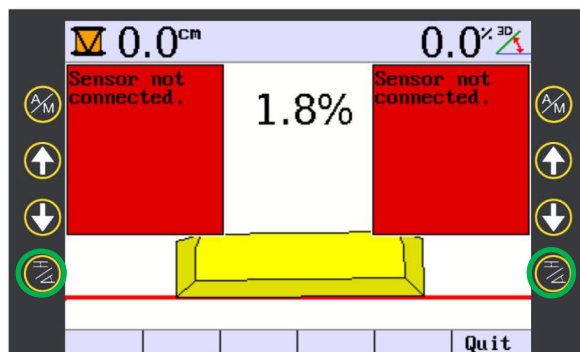

Step 2: Press the configure button on the relevant side to open the sensor menu. Masts mounted in the middle is configured on the left side.

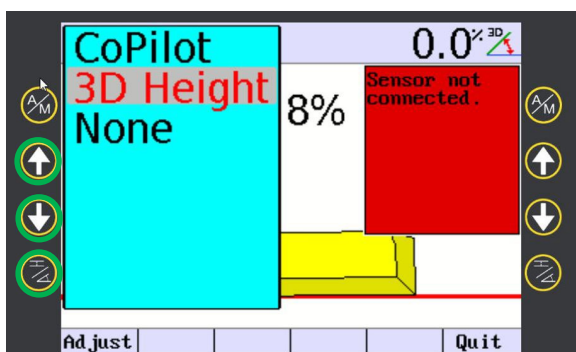

Step 3: Press the arrow buttons to find "Laser" in the sensor menu. Continue to step 10 if laser is available. If "Laser" is not available in the sensor menu list, you need to change to tech-mode. Press the configure button to close the sensor menu.

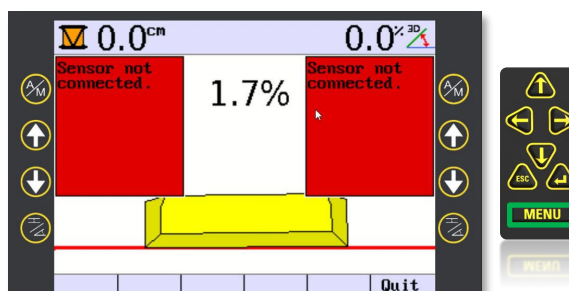

Step 4: Press the "Menu" button on the hardware to adjust mode.

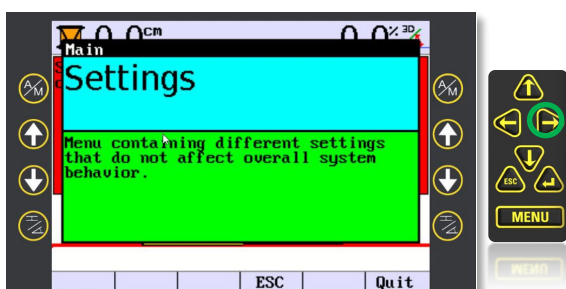

Step 5: Press the right button on the hardware until you find "Tech-Mode".

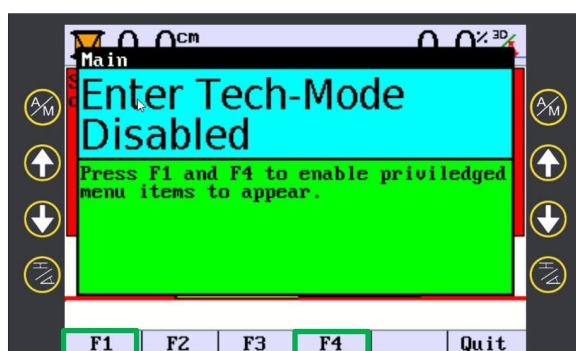

Step 6: Press the F1 and F4 hardware buttons simultaneously to switch tech-mode from "Disabled" to "Enabled".

Workflow 03: Adjust height of an electric mast (continued)

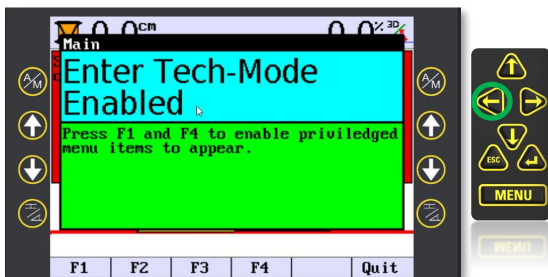

Step 7: When tech-mode is enabled press the left button on the hardware.



Step 8: Press the "ESC" button to exit to the CB14 run screen. Press the configure button.

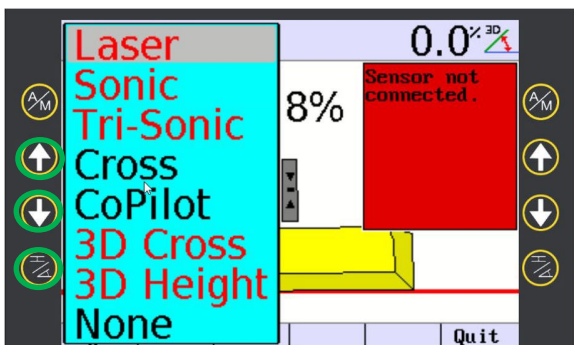

Step 9: Use the arrow keys to select "Laser". Press the configure button to exit the sensor menu.

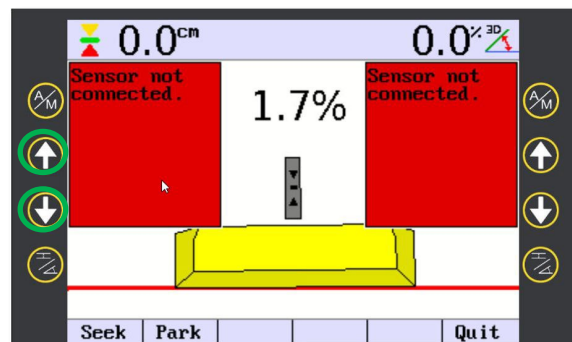

Step 10: Use the arrow keys to move the mast up or down.

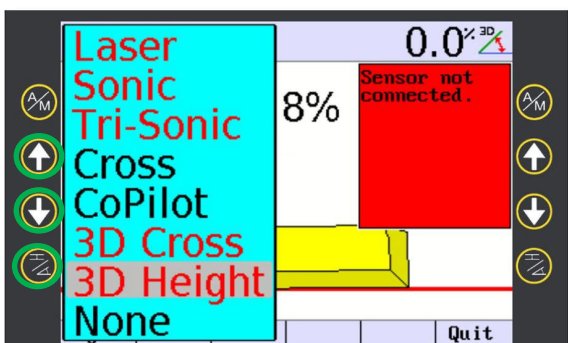

Step 11: Press the configure button to reopen the sensor menu and select "3D Height" with the arrow keys. Press the configure button to exit the menu.

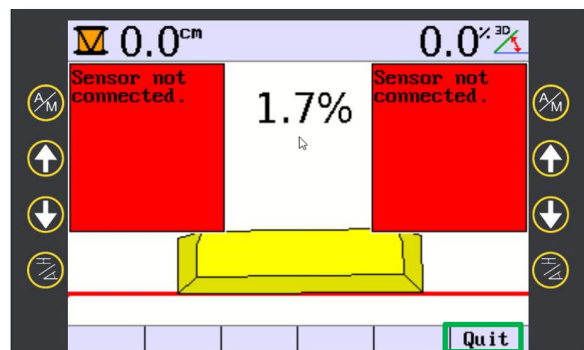

Step 12: Press "Quit" to exit to the MC1 run screen.

Step 13: When you are done working with the adjusted mast repeat steps 1-10 to reset mast height. Press "Park" in Step 10.

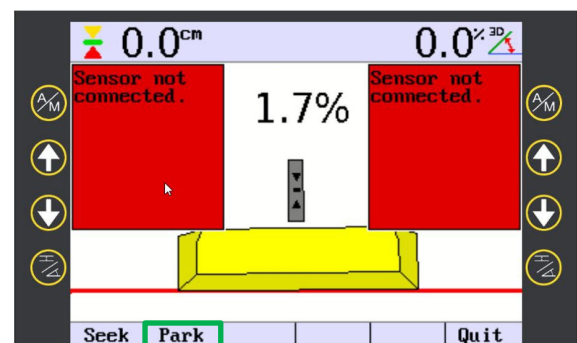

3. Your 2D solution

Workflows in this chapter focus on your 2D machine control solution.

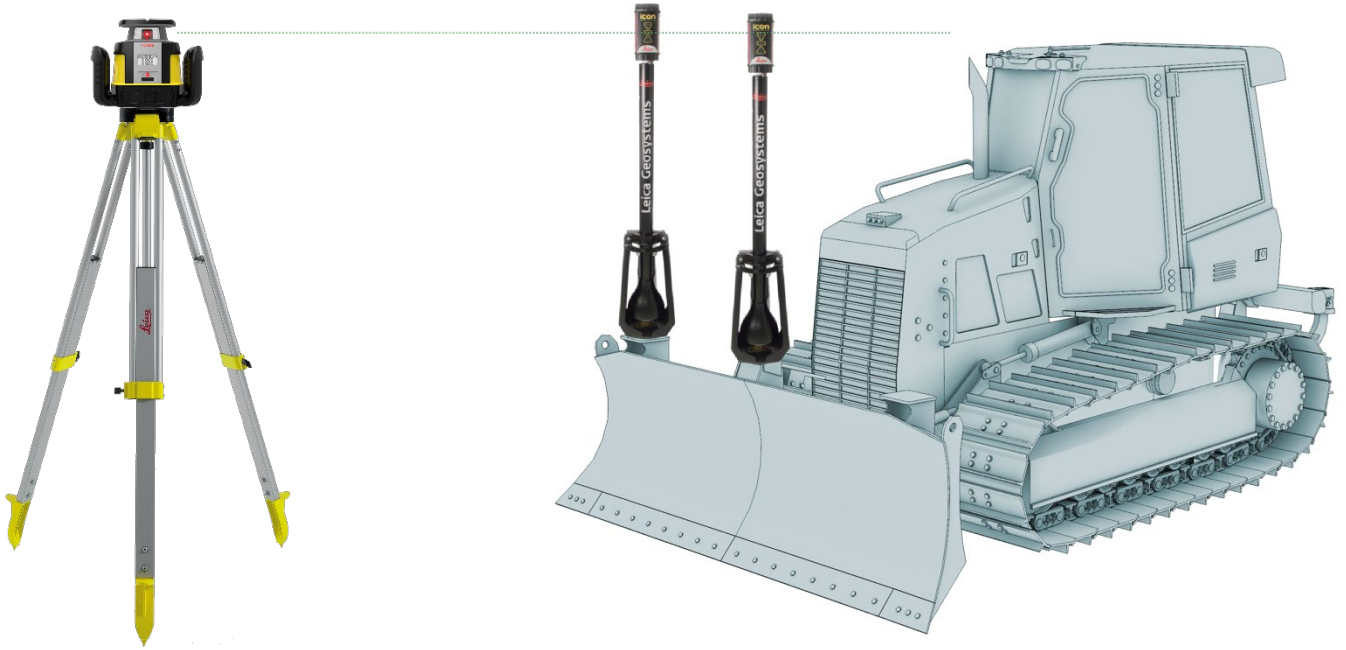

2D solution content:

- **Workflow 01:** Switch from 3D to 2D mode
- **Workflow 02:** Operate your machine with "cross slope" only
- **Workflow 03:** Operate your machine with "CoPilot"
- **Workflow 04:** Understanding CoPilot modes
- **Workflow 05:** Laser setup considerations
- **Workflow 06:** Set up a laser to create dual sloping surfaces
- **Workflow 07:** Operate your machine with laser receiver + cross slope
- **Workflow 08:** Operate your machine with "dual" laser receivers
- **Workflow 09:** Configure sensor position without the MJB130x junction box

Workflow 01: Switch from 3D to 2D mode

This workflow shows you how to switch from 3D to 2D work mode in MC1.



Step 1: Press "Positioning" menu.

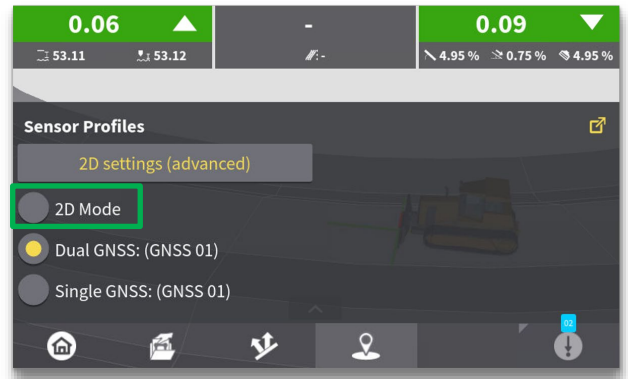

Step 2: Press "2D mode" to enter 2D mode.

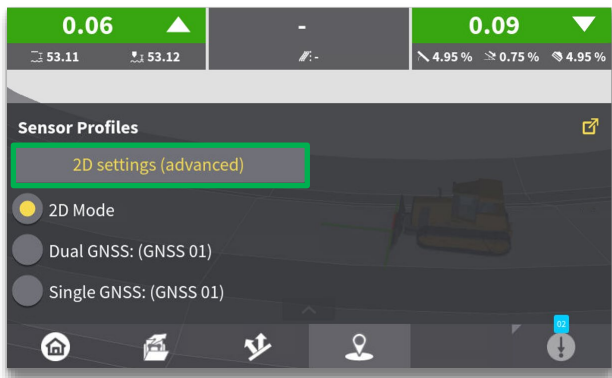

Step 3: Press "2D settings (advanced)" to access the CB14/2D run screen.

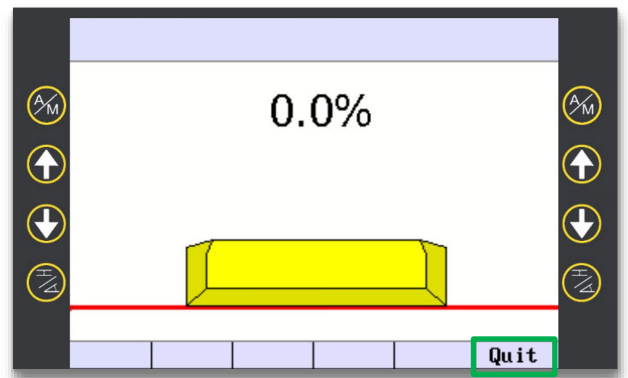

Step 4: Select sensors to use, and start working in 2D mode.

When needed, press "Quit" (panel hardware button) to return to the MC1 run screen. Remember to re-select a 3D sensor profile to return to 3D mode in the MC1 run screen.

Workflow 02: Operate your machine with "cross slope" only

With only a cross slope sensor, and if hydraulics are available, cross slope automatics is used with this configuration. Manually adjusting height for elevation is required.

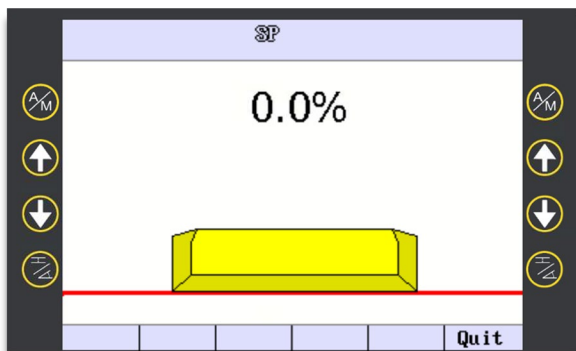

Step 1: Access 2D user interface (See [Workflow 01](#))

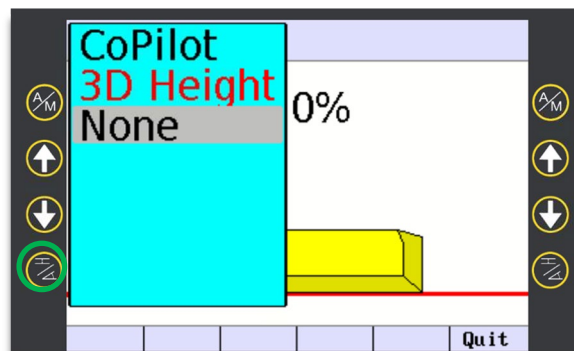

Step 2: Select "left side" configure softkey and use up/down arrows to select "None" for the Left tip configuration.

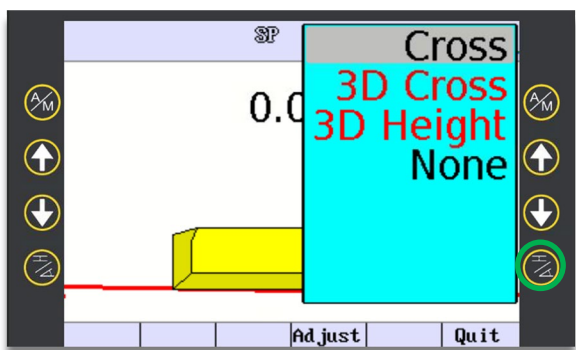

Step 3: Select "right side" configure softkey and use up/down arrows (Softkey or Keypad) to select "Cross".

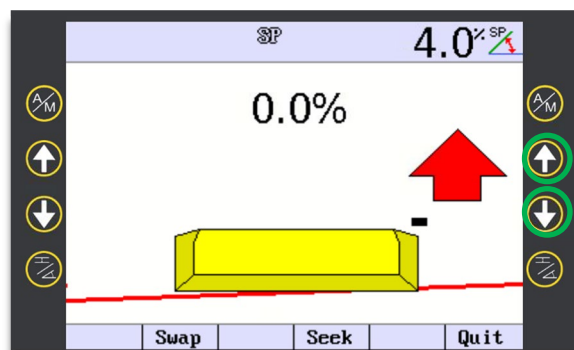

Step 4: Use right side "up/down" softkeys, to dial in desired slope. An arrow will indicate the direction the blade needs to move to match the slope.

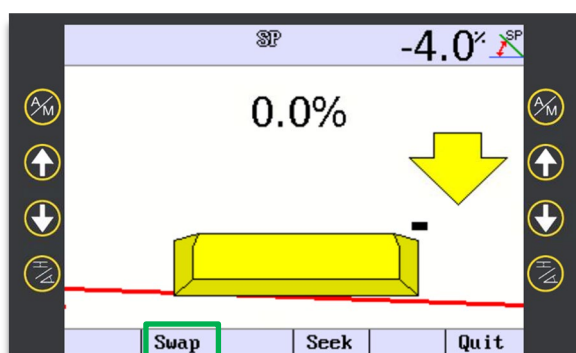

Step 5: Select the "Swap" hard key to change slope direction.

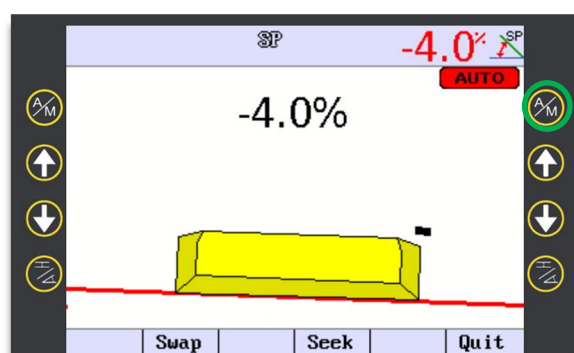

Step 6: Select A/M to engage automatic hydraulic functions (If equipped) and the blade will move to the desired slope.

Workflow 03: Operate your machine with "CoPilot"

The "CoPilot" system helps you create a smooth flat surface. It maintains long slope without the need for height reference through laser receiver. Cross slope is always available, and can be set in the display. CoPilot requires installation of the basic "2D" system and an "SP14" sensor (Connected to left side of quick dis-connection box). You can use CoPilot together with an auto/manual switch, for control of hydraulics.

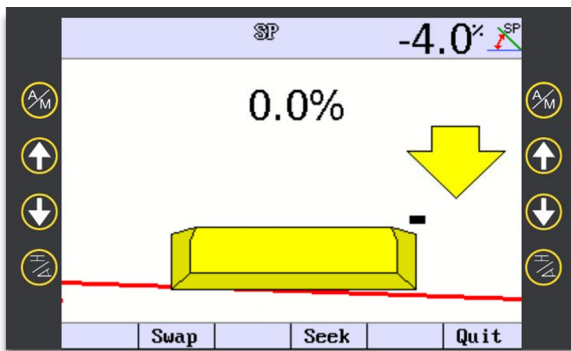

Step 1: Access 2D user interface (See [Workflow 01:](#))

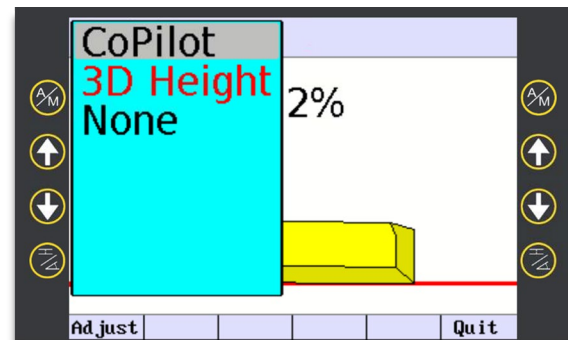

Step 2: Select "left side" configure softkey and use up/down arrows (Softkey or Keypad) to select "CoPilot". Press "Config" or "Enter".

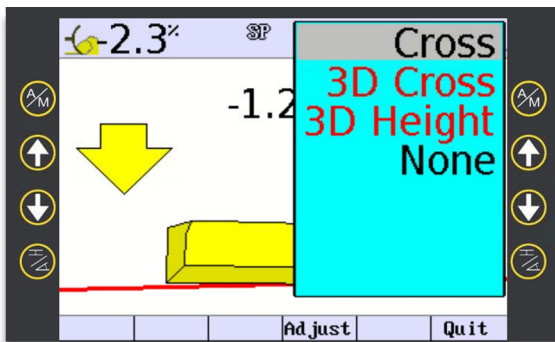

Step 3: Select "right side" configure softkey and use up/down arrows (Softkey or Keypad) to select "Cross". Press "Config" or "Enter".

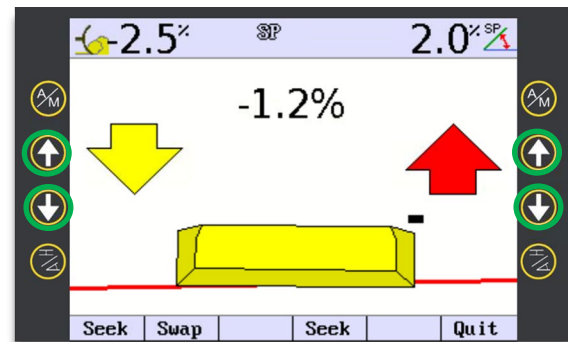

Step 4: Use softkey arrows to set desired slope (Long slope set on left, and cross slope set on right). The system will guide you to the correct grade.

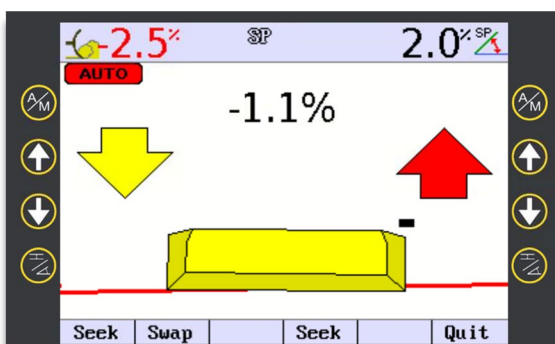

- CoPilot functions as configured in "Workflow 04: Understanding CoPilot Modes".

Workflow 04: Understanding CoPilot modes

CoPilot uses information from the SP14 sensor when storing long slope values of your reference surface. You need to set the benchmark (zero) value with the blade itself. There are two ways to use CoPilot: **01) Zero on Auto YES** and **02) Zero on Auto NO**. In both modes, when cross slope side is put into "Auto", cross slope maintains the value that was dialled in.

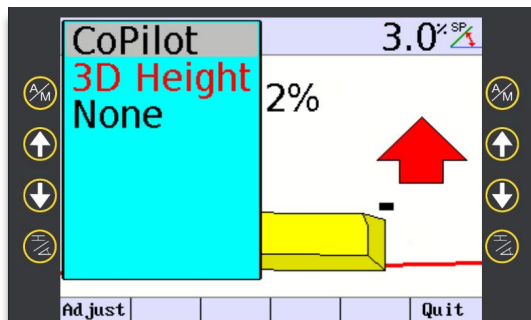

Step 1: Select "left side" configure softkey (In "2D UI" configured for CoPilot).

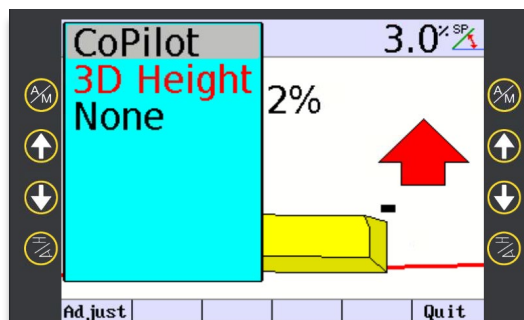

Step 2: Select "F1" / "Adjust" (Text may be hidden by config menu).

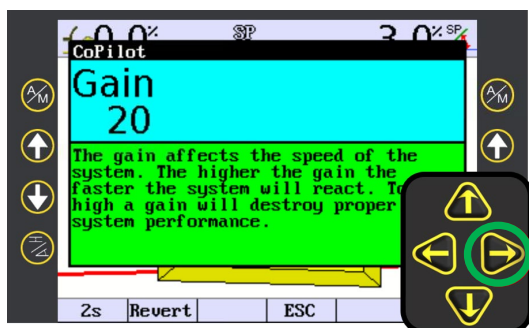

Step 3: Press "right" hard key.

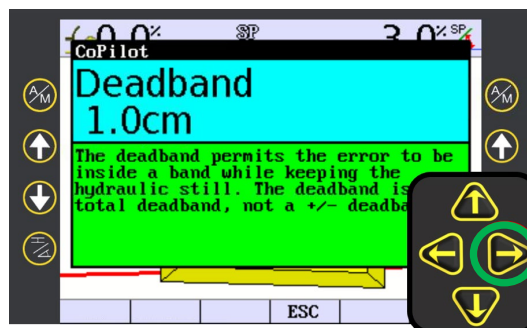

Step 4: Press "right" hard key.

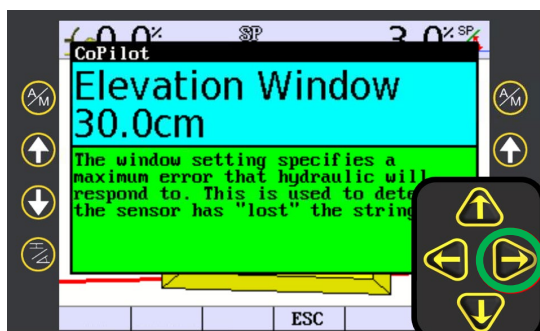

Step 5: Press "right" hard key.

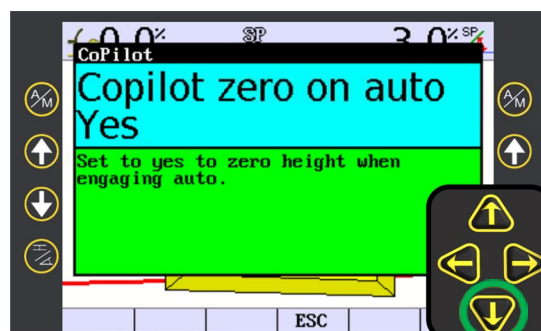

Step 6: Press "down" hard key to select "Yes/No" (See next page for definition of Yes/No options).

Workflow 04: Understanding CoPilot modes (Continued)

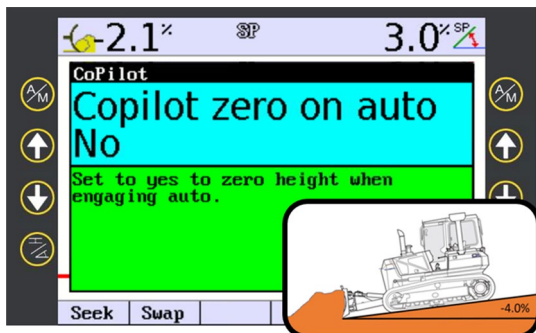

- No = New reference angle is generated only when you press "Seek", or dial in desired long slope.

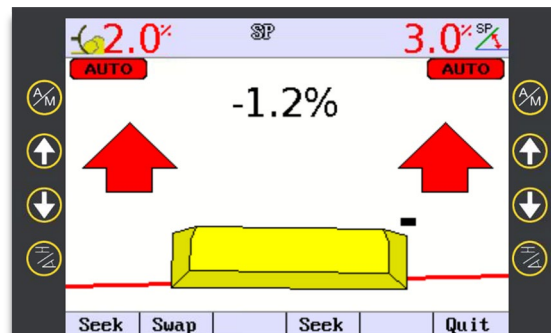

- When auto is engaged, previously set long slope will be retained. CoPilot will NOT adjust long slope unless "up/down" softkeys are used to adjust values, or "Seek" is pressed to match current SP14 values.

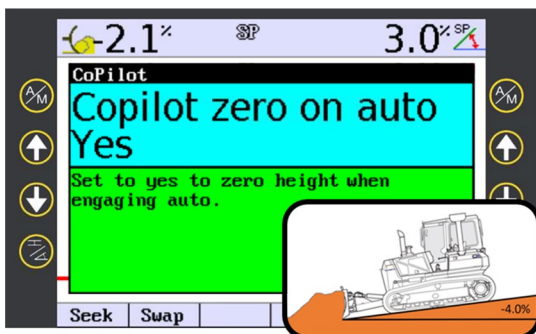

- Yes = Every time you press "auto" button, a new CoPilot long slope reference surface is generated, based on blade position at that moment.

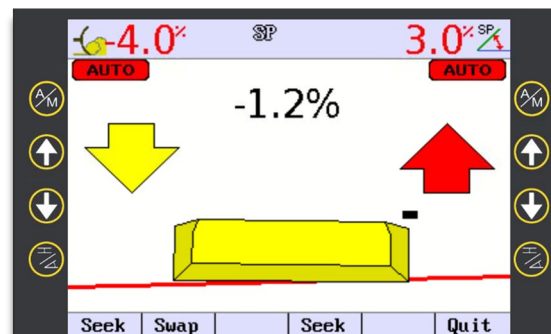

- When auto is engaged, CoPilot will match long slope of the blade in its current position. If a different long slope percentage is desired, use "up/down softkeys to adjust while in auto."

Workflow 05: Laser setup considerations

Set up a machine control laser for optimum coverage of the job site. It must be out of traffic and any obstructions. Position laser and tripod at a height equal to the laser receiver mounted on your machine, when it is on grade. Adjust alignment of your laser to the site as needed.

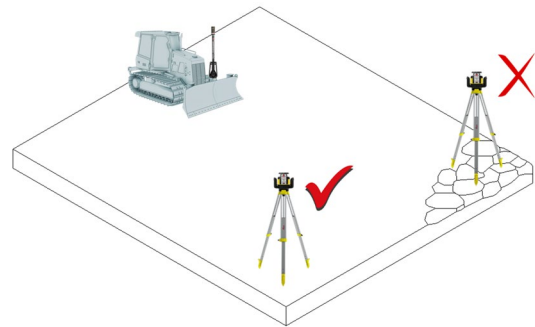
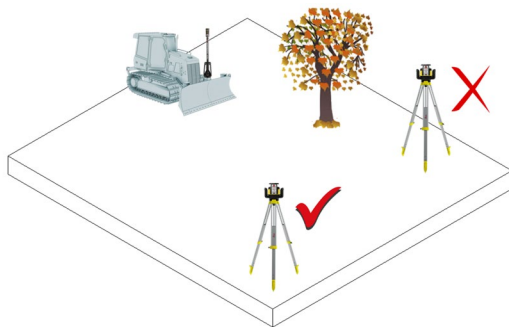

Step 1: Choose a good location for your laser.

- No obstructions that could block or reflect the laser.

- Stable ground, so the tripod won't shift or settle (Ground Vibration can affect operation of the laser).

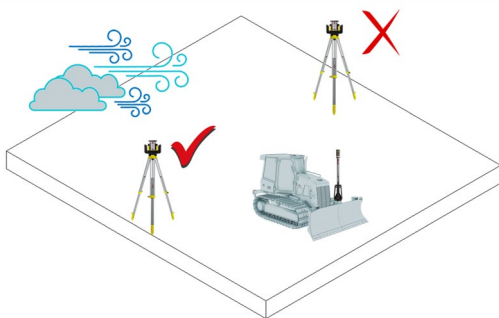

- Up-wind, in very dusty environment, so dirt is blown "away" from your laser.

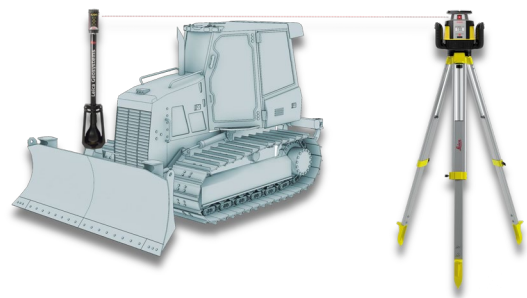

Step 2: Adjust height of your laser beacon and laser sensor:

- Height should, if possible, be above cab (This prevents cab, or roll-over structure, from blocking your laser).



Step 3: Check tripod, then attach your laser.

- Make sure all tripod screws, bolts and nuts are tight.
- Place laser on tripod and tighten screw on underside to secure it to the laser tripod.
- If your tripod has chains, those chains should be slightly loose to allow for thermal expansion during the day.
- Secure your tripod in very windy conditions.

Workflow 06: Setup a laser to create dual sloping surfaces

Dual Sloping surfaces are defined by a master alignment (Y) and a cross-slope on either side (X). Optionally an additional hub can be set for height reference (Z) along the X-axis.

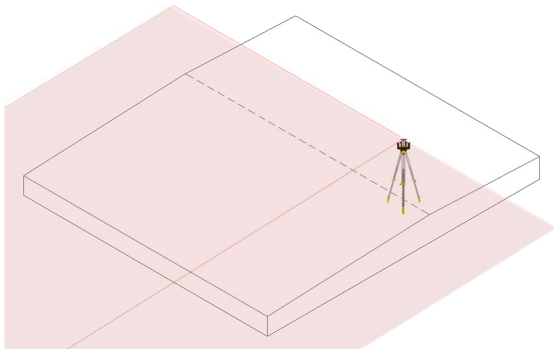

Step 1: Choose optimum laser location:

- The location should allow you greatest possible working range on your site.

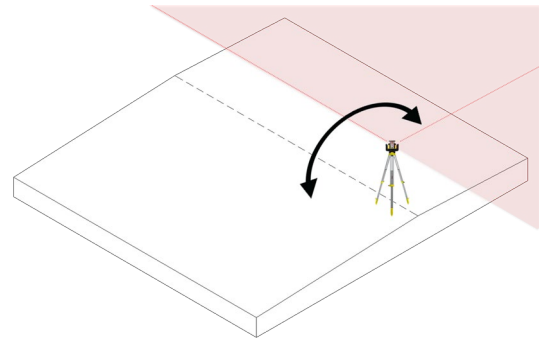

- If the slope is mirrored, and if grading will be done on both sides, it is helpful to place your laser on the crown (This way the grade can be swapped on the laser without additional setup).

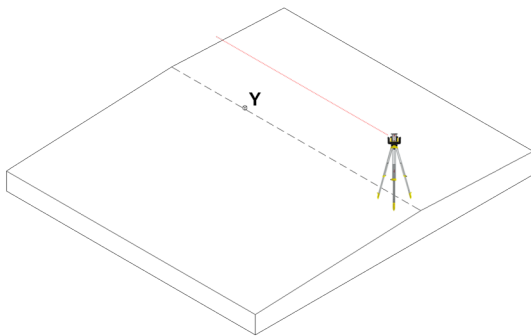

Step 2: If the grade has a dual slope, have the surveyor set hubs along X and Y axis.

- Y axis defines CL and machine long slope (Align your laser precisely with this CL).

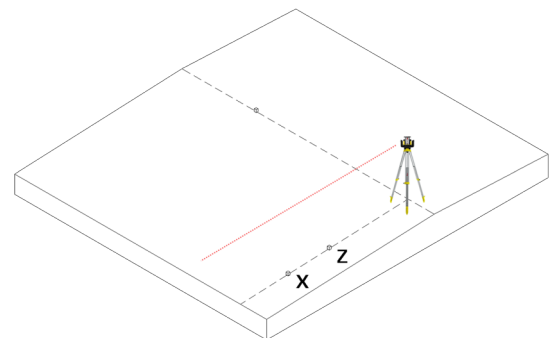

- One hub along X axis will be used for "height benchmark" the other for cross slope (Adjust laser based on this X-slope).

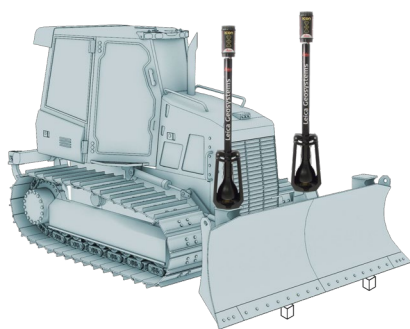

- X-axis hubs can be used to establish cross slope manually, as pictured here. If an X-slope sensor is installed, slope can also be dialed in to match the laser.

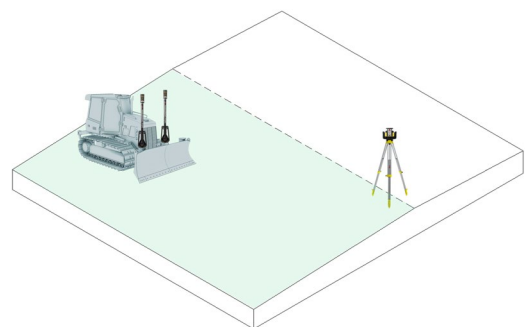

Step 3: Place the blade at desired working height. Adjust the laser receiver on your machine to catch the laser strike, at the center. Now, grade on the slope that matches the laser.

Workflow 07: Operate your machine with laser receiver + cross slope

Single Laser is an economic option, but you must be aware of the travel direction when grading. Travel diagonally across a slope will provide incorrect guidance with single laser. Cross slope values must match entered value in laser, and the blade must not be rotated.

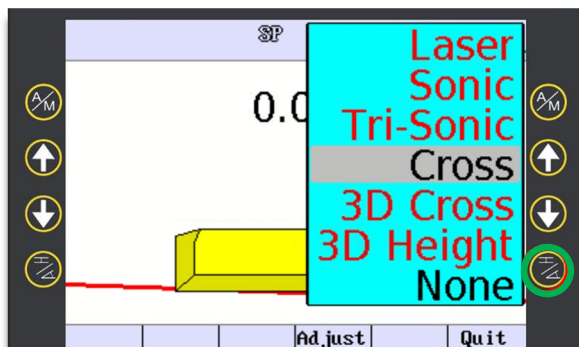

Step 1: Press "right side" configure softkey, and select "Cross".

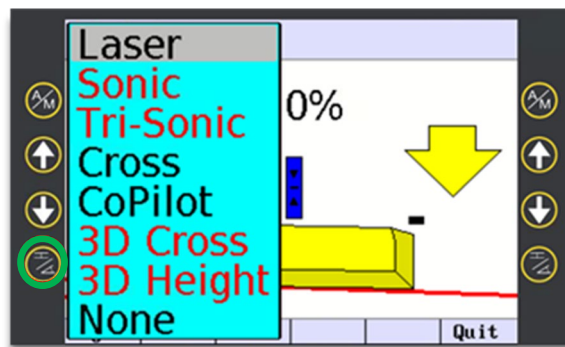

Step 2: Press "left side" configure softkey, and select **Laser**.

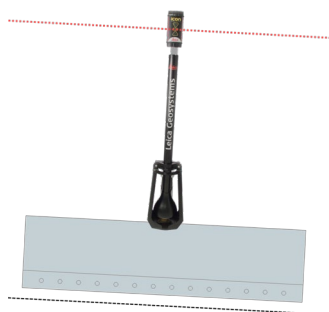

Step 3: Place blade on desired cross slope. Move laser receiver until green "on grade" indicators show. Alternatively, if using power masts, use "Seek" softkeys in + direction.

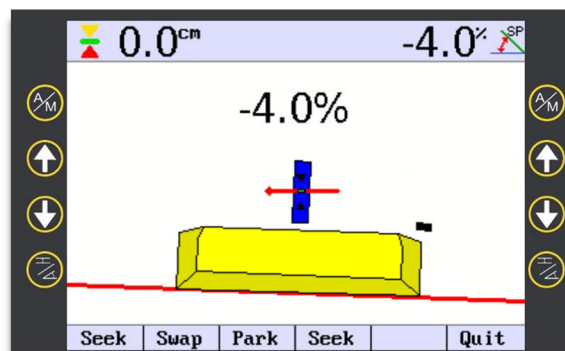

- When laser receiver is within laser strike, a red horizontal arrow appears on screen.

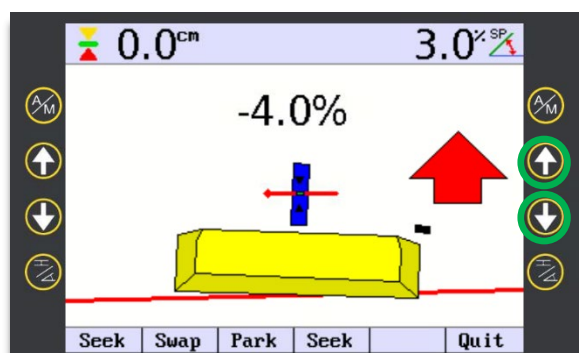

Step 4: Use "up/down" softkeys to dial in desired cross slope matching laser value. An arrow indicates the direction the cross slope controlled tip should move to be on grade.

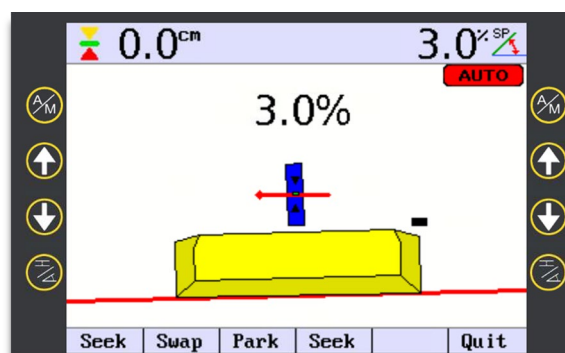

Step 5: Select A/M softkey on cross slope side to enable automatics. When "on grade", the arrows will NOT appear, and centre line of laser catcher illuminates green. Auto switch function has 4 options, selectable by tech.

Workflow 08: Operate your machine with "dual" laser receivers

When working with dual laser you can run your machine in any direction, regardless of slope. Cross slope of blade will be determined by laser cross slope. With dual laser you are free to rotate the blade if necessary. Desired cross slope must match the slope that is dialled into the laser.

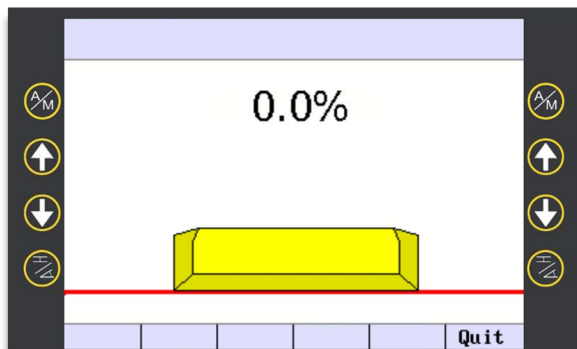

Step 1: Access 2D user interface (See [Workflow 01](#)).

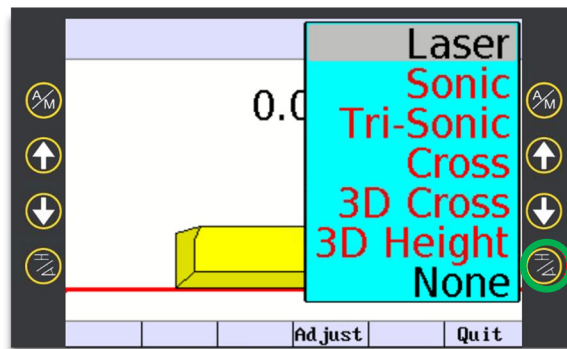

Step 2: Press "right side" configure softkey, and use up/down arrows (Softkey or Keypad) to select "Laser".

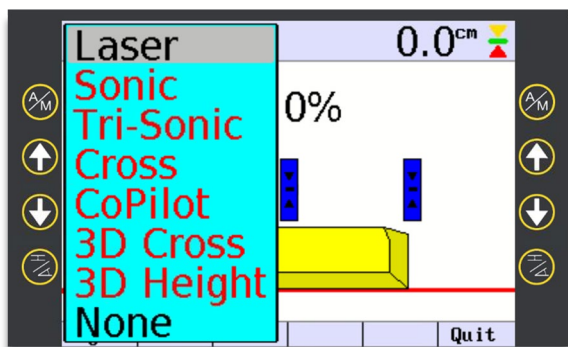

Step 3: Select "left side" configure softkey, and use up/down arrows (Softkey or Keypad) to select "Laser".

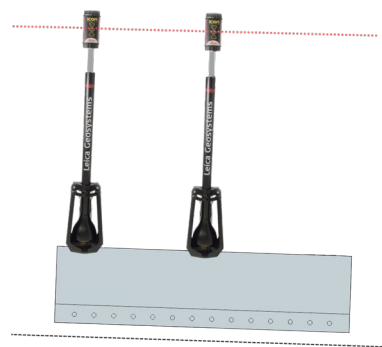

Step 4: Place blade on desired cross slope. Move laser receiver until green "on grade" indicators show. Alternatively, if using power masts, use "Seek" softkeys in + direction.

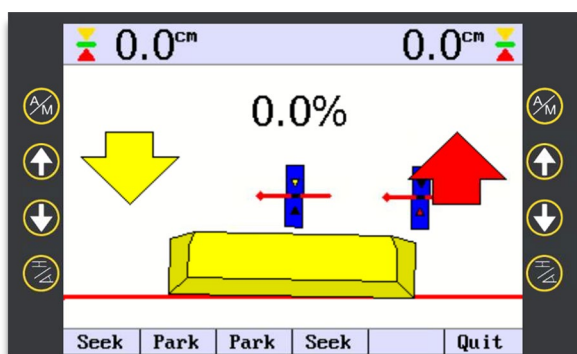

- When laser receivers are within laser strike a red horizontal arrow appears on screen. Other arrows indicate the direction each tip should move to be on grade.

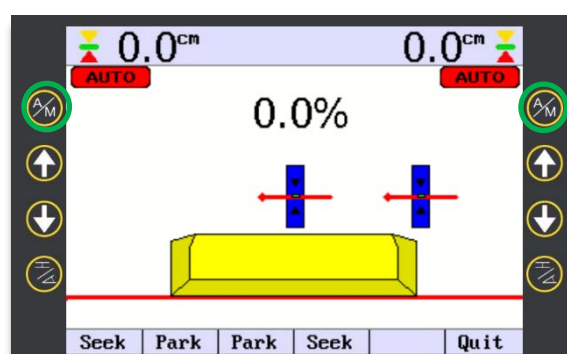

Step 5: Press A/M softkey, on either sides, to enable "Automatic". When "on grade" the arrows will not appear, and centre line of laser catcher illuminates green. Auto switch function has 4 options, selectable by tech.

Workflow 09: Configure sensor position without the MJB130x junction box

This workflow is only relevant for systems that does not have an MJB130X junction box. If you do have an MJB130x junction box, then the sensors must be set to left. The workflow describes how to program 2D sensors for left or right-side mounting for a single or dual sensor setup. It is temporarily necessary to go through these steps if you do not have the MJB130x junction box installed in the system.

Supported sensors (minimum software requirement: CB14 on MCP80 v. 2.91 and CB14 on SJB22 v. 4.2.0):

- **MLS720** laser receiver (serial numbers after 20209488 / 06.01.2020).
- **MLS820** laser receiver.
- **MUS1400** tri-sonic sensor.
- **MPM700** electric mast (serial numbers after 30101870 / 14.11.2022).

Older sensors can be used only as a left sensor alone or with a new sensor as the right.

NOTES:

- Disconnect all sensors that should maintain current mount side configuration.
- Only connect the sensor you want to reconfigure.
- All sensors are by default left side configured.

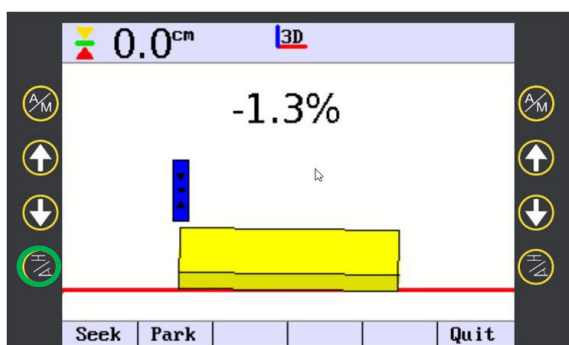

Step 1: Access 2D user interface. Press the left side configure button.

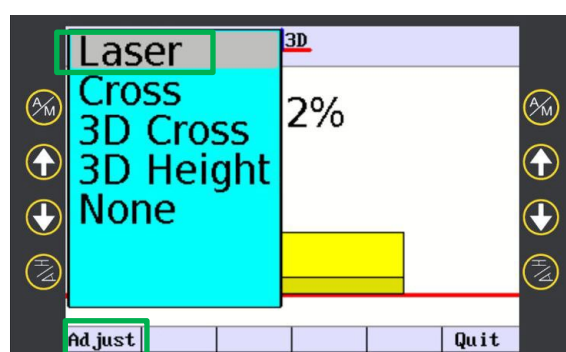

Step 2: Select "Laser" and press "Adjust" to enter the "Adjust Mount Side" menu.

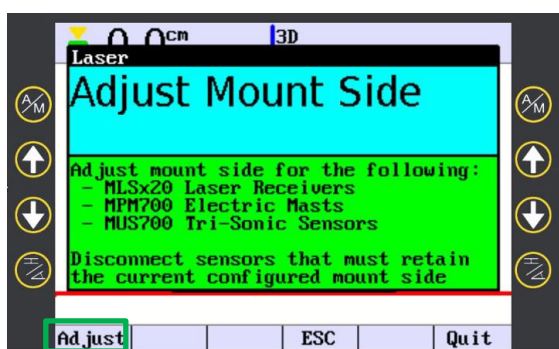

Step 3: Press "Adjust".



Step 4: Read through the instructions. Press "Left" or "Right" to set mount side for connected sensor.

Workflow 09: Configure sensor position without the MJB130x junction box (continued)

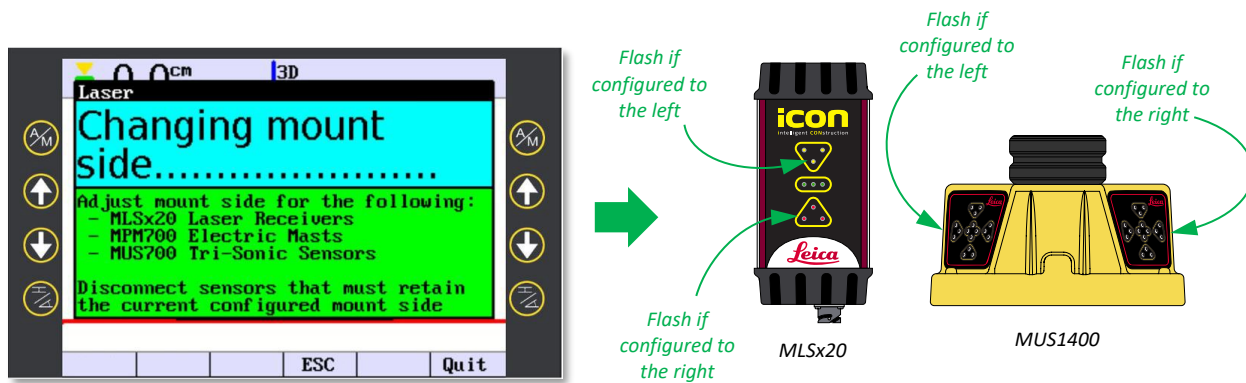

Step 5: Verify mount side configuration.

During power-up and side configuration:

- MLSx20 sensor: The top LED will flash for two seconds if mount side is configured to the left. The bottom LED will flash for two seconds if mount side is configured to the right.
- MUS1400 sensor: The left LED will flash two seconds if mount side is configured to the left. The right LED will flash for two seconds if mount side is configured to the right.
- MPM700 mast: No flash indication for mount side configuration.

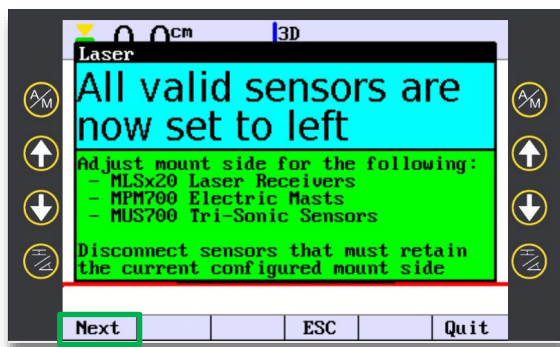

Step 6: Press "Next" to continue configuring.

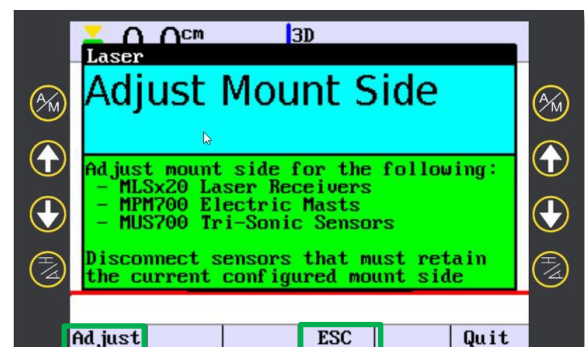

Step 7: Press "Adjust" to configure right-side sensors for a dual setup. If you only need a left-side configuration, press "ESC" to exit to run screen.

4. Your 3D solution

Workflows in this chapter focus on your 3D machine control solution.

The first five pages gives you essential background information, intended to help you better understand and use the workflows described further on.

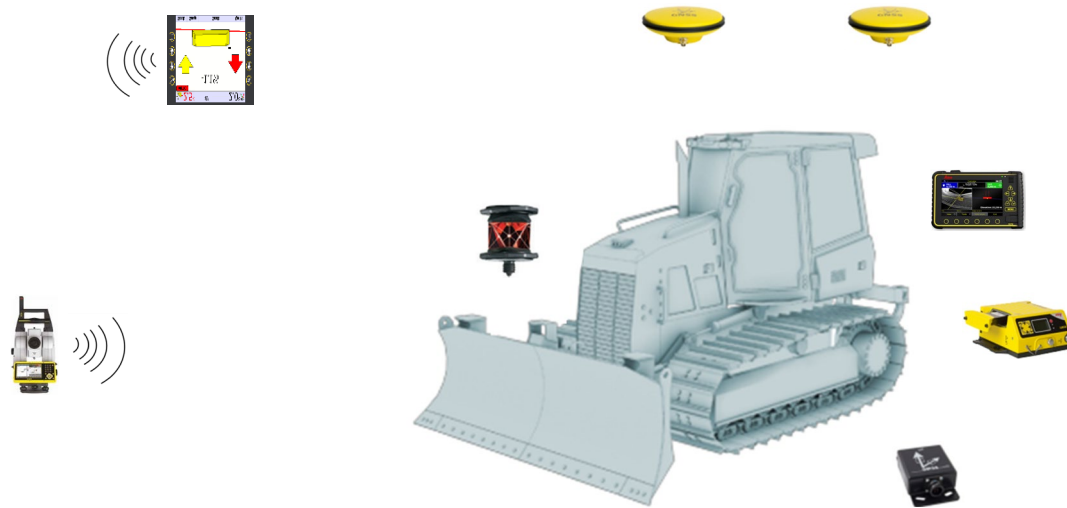

3D solution content:

- ① Touch navigation
- ① GNSS basics
- **Workflow 01:** Find your project and models
- **Workflow 02:** Select and use references from the run screen
- **Workflow 03:** Offset a model reference
- **Workflow 04:** Offset individual references
- **Workflow 05:** Enter temporary mast height
- **Workflow 06:** Change "height tool point"
- **Workflow 07:** Change "side tool point"
- **Workflow 08:** Select and use "height reference"
- **Workflow 09:** Select and use "side reference"
- **Workflow 10:** Daily machine check-in
- **Workflow 11:** Adjust blade wear
- **Workflow 12:** Activate auto mode
- **Workflow 13:** Create point logs
- **Workflow 14:** Synchronize files

Touch navigation

The MCP80 panel display allows multi-touch navigation of run screens.

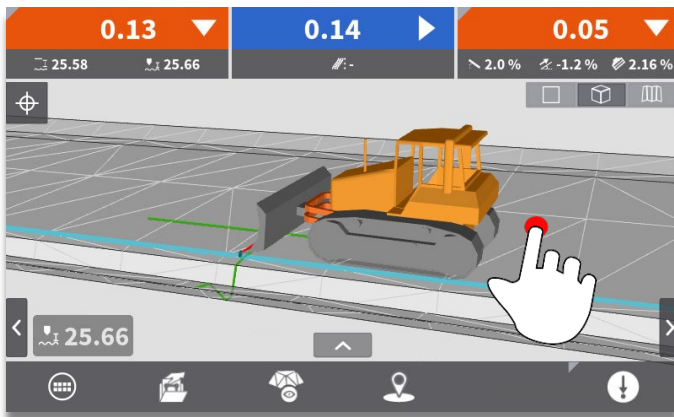

Single finger tap: Show navigation controls.

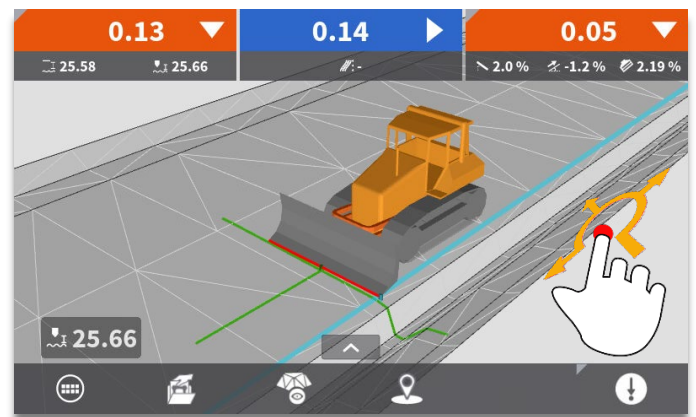

Single finger press and drag: Rotate view.

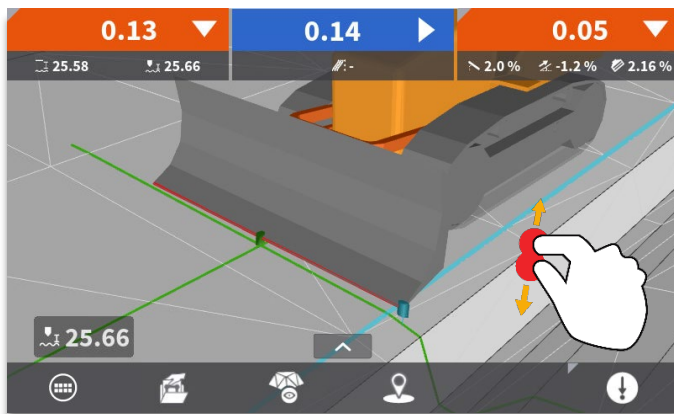

Pinch close: Zoom in.

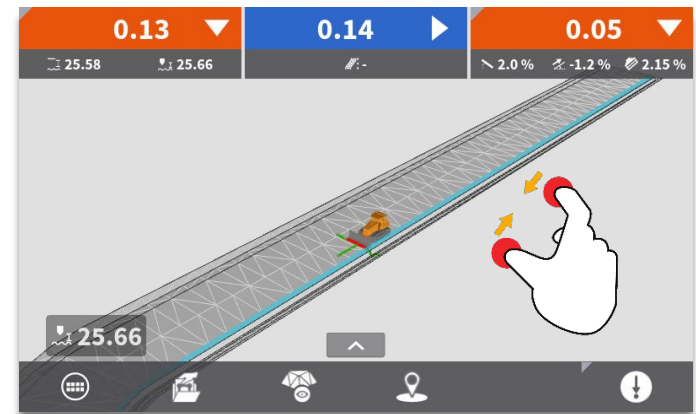

Pinch open: Zoom out

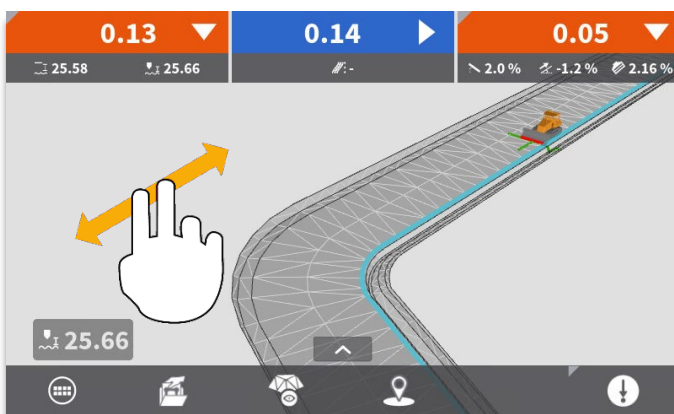

Two-finger press and drag: Pan.

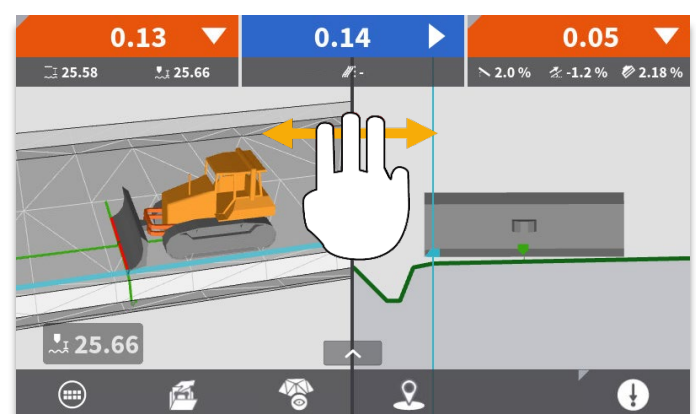

Three-finger press and drag horizontally: Change View.

GNSS basics

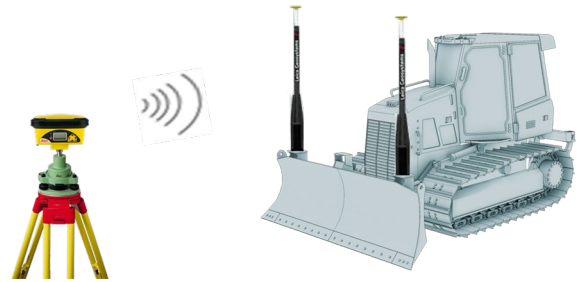
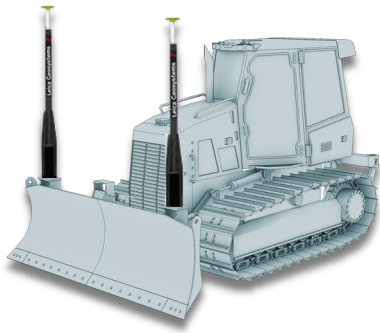

- When using GNSS, your machine must be within radio range of the local base. Alternatively, if you use an internet base, your machine must be connected via modem.

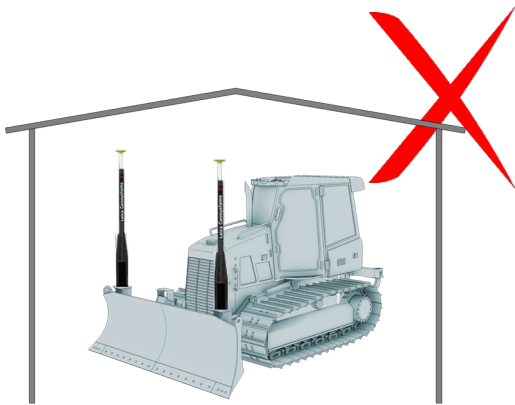

- GNSS Signal cannot be used indoors or under a canopy of trees.

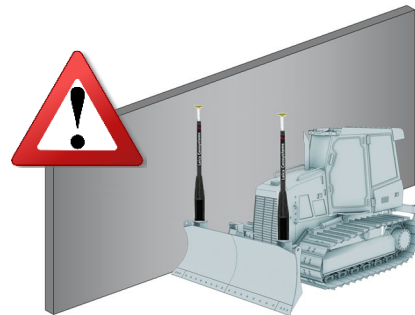

- When operating close to large reflective surfaces (Such as billboards or windows) positioning quality could be affected.

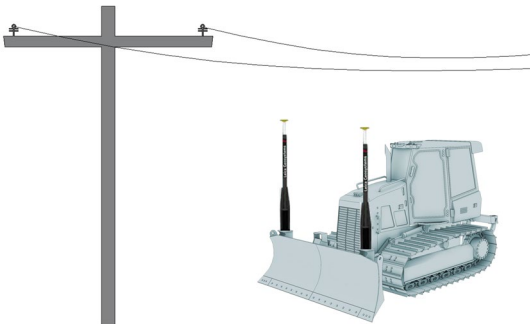

- When operating near "high power" lines, positioning quality could be affected.

Workflow 01: Find your project and models

Multiple models can be loaded for a project, and several references can be made available for selection in the command centre. The command centre can be accessed from the run screen, or in "Projects" menu. If you already have all necessary files loaded for your project, skip ahead to "Step 4".

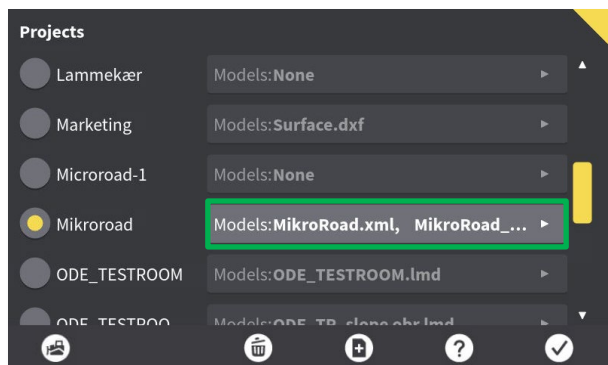

Step 1: Press the menu next to the project you are using, to view model details.

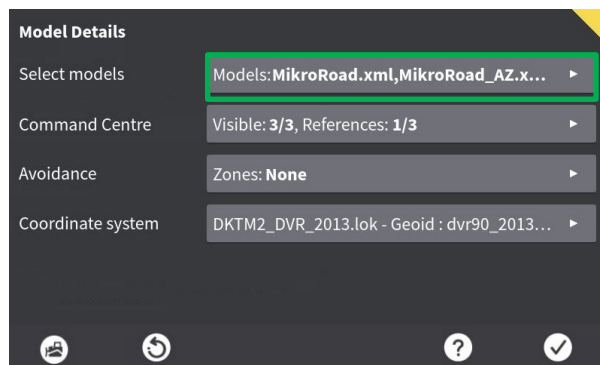

Step 2: Press the "Select models" menu, to access available models.

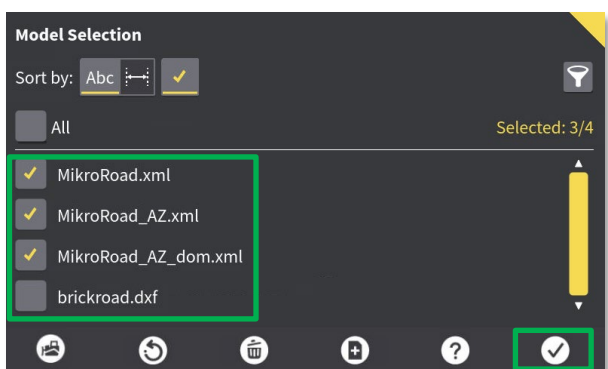

Step 3: Select models to be available in the command centre. Press the tick mark icon (OK) to return to previous menu.

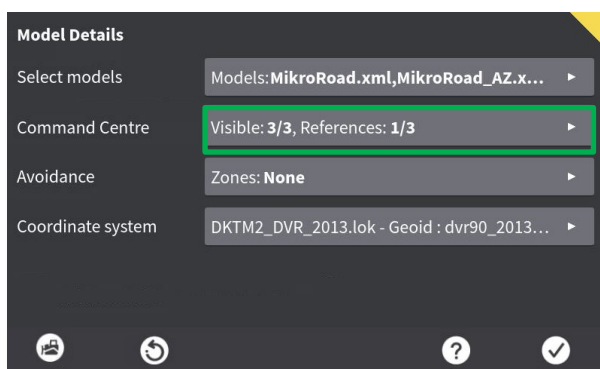

Step 4: Press the "Command centre" menu, to access available models. You can also access the command center from the run screen ([Workflow 02](#)).

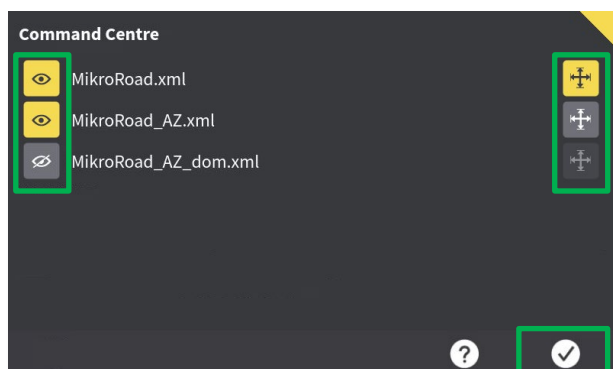

Step 5: Set which references that should be visible and available for selection in the run screen. Press the tick mark icon (OK) to return to previous menu.

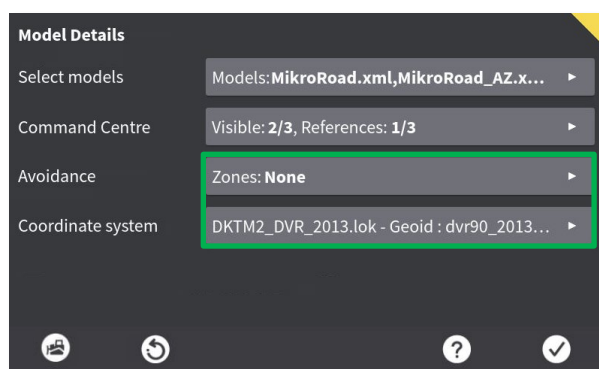

Step 6: (Optional) Select avoidance zone and coordinate system files in these menus. Press X to apply changes and return to run screen.

Workflow 01: Find your project and models (continued)

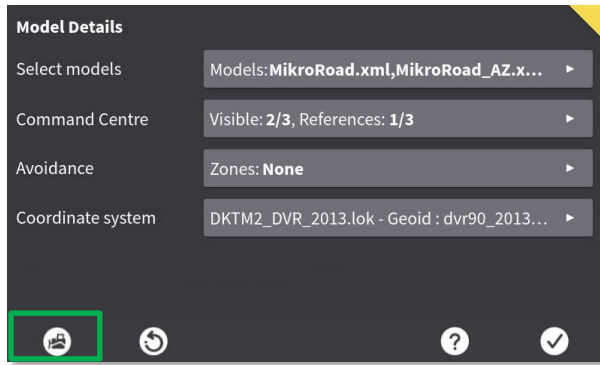

Step 7: Press the dozer icon to apply changes and return to run screen.

Workflow 02: Select and use references from run screen

Available models must be loaded in "Select models" menu (See [Workflow 01](#)). Once this is done, you can easily switch between models in the run screen. You can make multiple references from multiple models available for selection in the run screen.

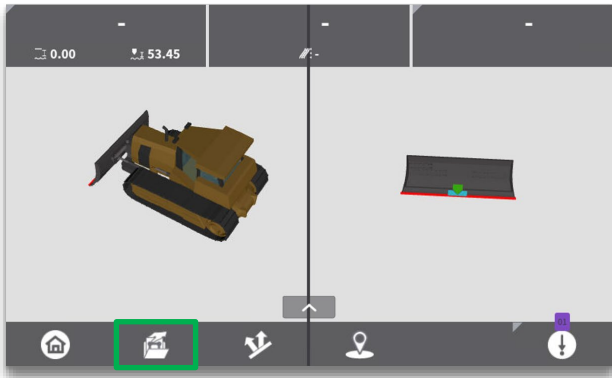

Step 1: Select "Command centre" menu.

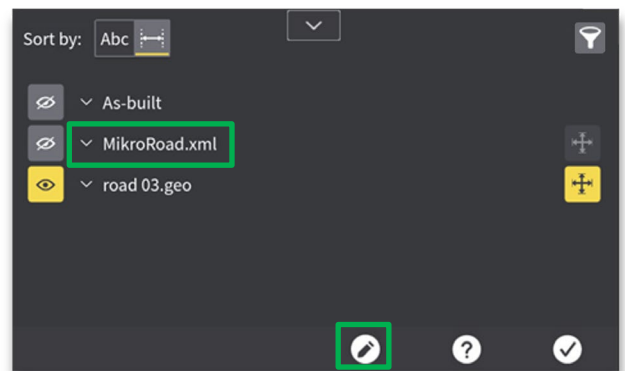

Step 2: Press a model to view the references within. If needed, press the "pencil" icon to access the "Select models" menu, where you can add or remove models in the command centre.

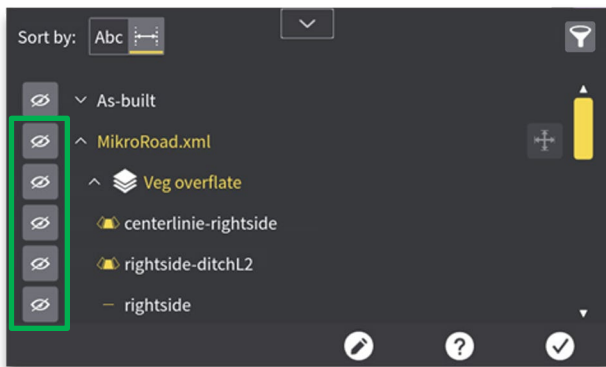

Step 3: Select the references you want to make visible in the run screen. You may need to expand the model further to see all references.

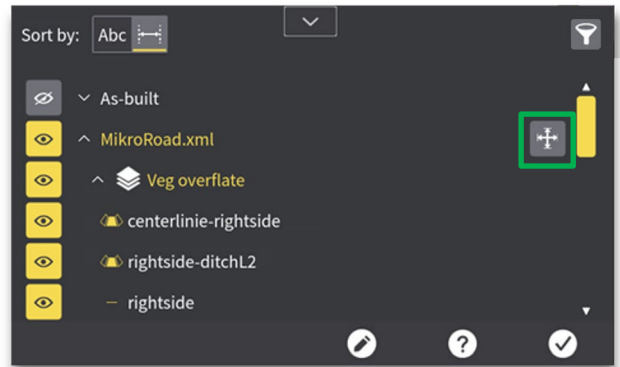

Step 4: Select which references you want to make available for use in the run screen.
NOTE: references cannot be made available for use in the run screen if visibility is turned OFF.

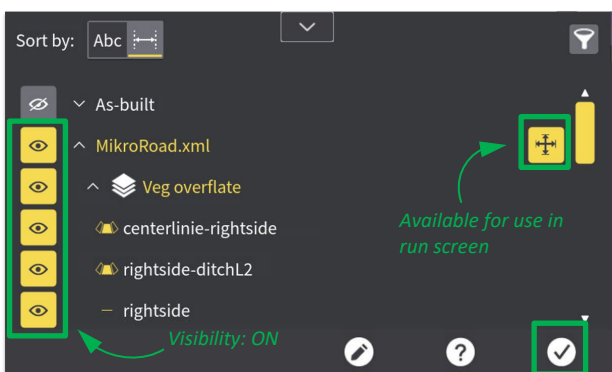

Step 5: Press the tick mark icon (OK) to return to the run screen.

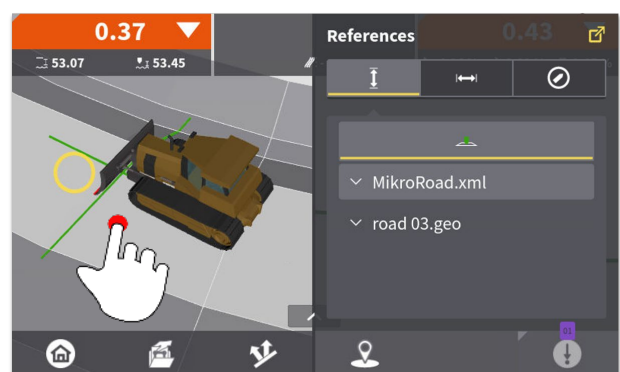

Step 6: Press and hold on the model to see the "References" menu. In this case the height reference tab is selected. Press one of the other tabs if needed.

Workflow 02: Select and use references from run screen (continued)



Step 7: Expand the model containing the references you want to work with.



Step 8: Select the desired height reference ("centerlinie-rightside" shown here).



- A confirmation message is shown briefly (no need to acknowledge this message).

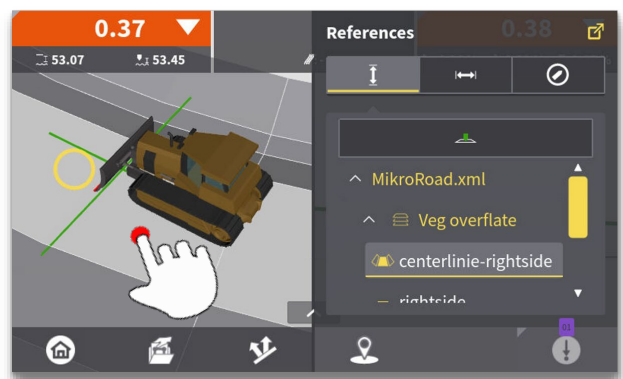

Step 9: Tap anywhere in the plan view to exit the "References" menu.



- The selected reference will be represented by a bold green line. Cut/fill will be provided to this reference and design cross-slope and long slope will update to reflect the height reference selected.

Workflow 03: Offset a model reference

When working outside of auto range limit, offsetting the reference model allows you to utilize automatics, and thus work more efficiently. Set height offset within "auto range limit". As the surface is being worked, the cut/fill values will reduce to zero as the grade approaches design elevation. Height offsets are used in relation to the machine's height tool point.

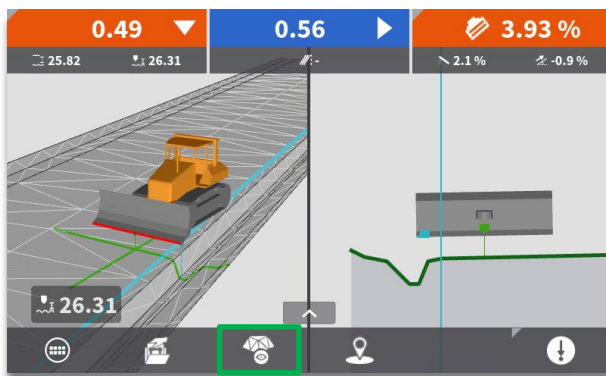

Step 1: Select "Offset" menu.

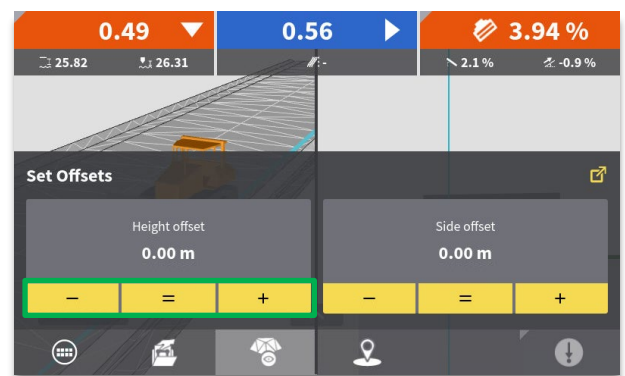

Step 2: Press - or + to offset your design by increments. Select = to set offset to current tool point height.

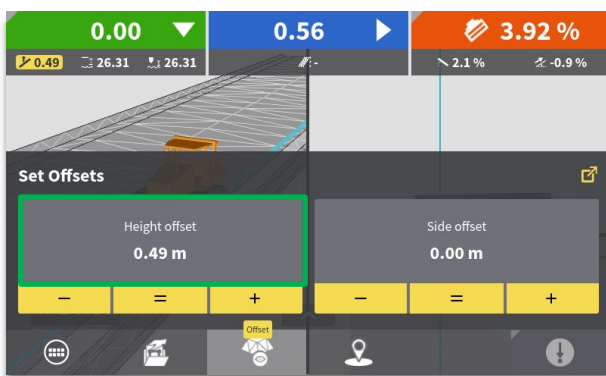

Step 3: Select the grey "Height offset" box for specific offset value input.

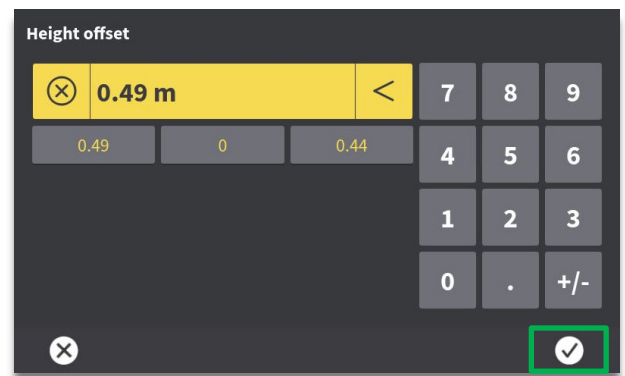

Step 4: Use keypad to input a value, and toggle the sign if necessary. A list of the last 3 height offset values are also listed for quick selection. Select check mark icon to accept value.

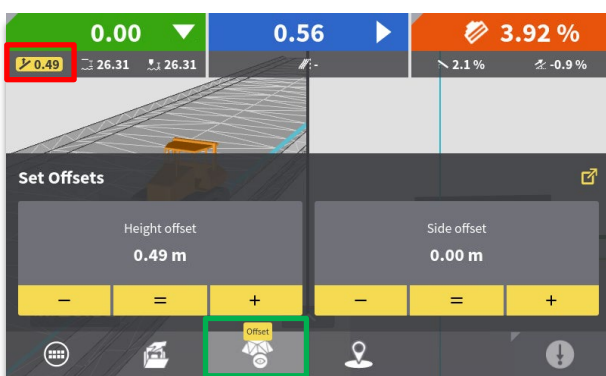

Step 5: Select the "Offset" menu icon to return to run screen. The offset value is shown in the top left corner.

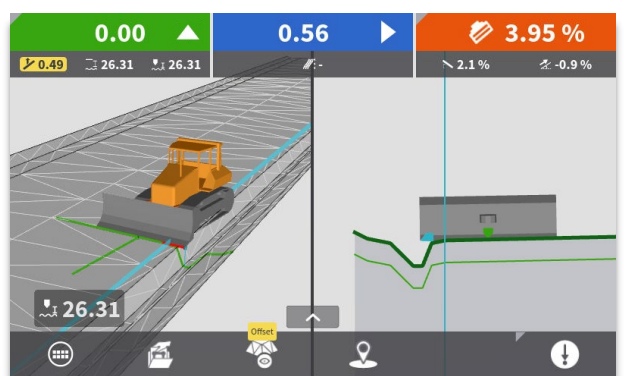

- Cut/fill values will be shown providing guidance to new height offset. Original grade will also be illustrated in x-section as a light green line.

Workflow 04: Offset individual references

In the expanded “Offsets” menu, you can offset individual references within a model. Only references and models eligible for height/side reference have the option to edit an offset value. Offsets are used in relation to the machine's tool point. Described workflow reflects Individual height offset, but the same workflow applies for individual side reference.

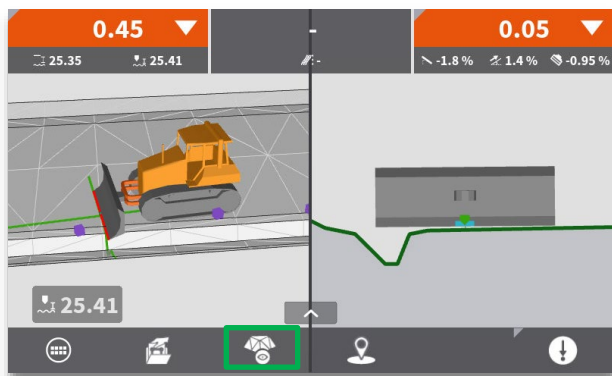

Step 1: Press the “Offsets” menu.

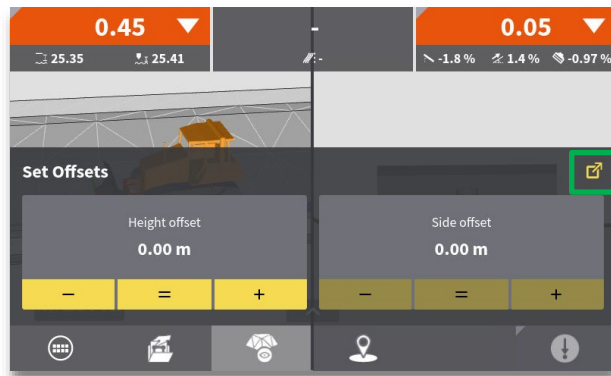

Step 2: Press the expansion button.

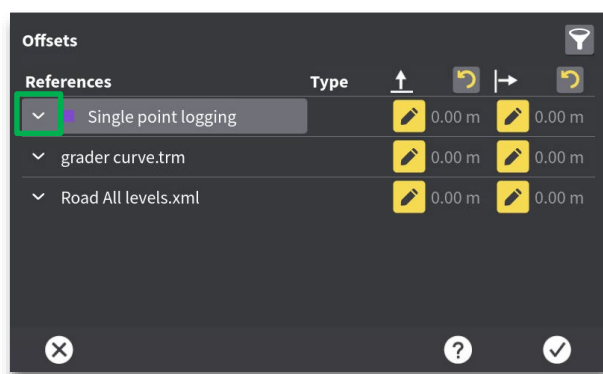

- Here you have a list of all the models available for use in the run-screen. Press the expansion arrow, a height and/or side offset can be applied to individual references.

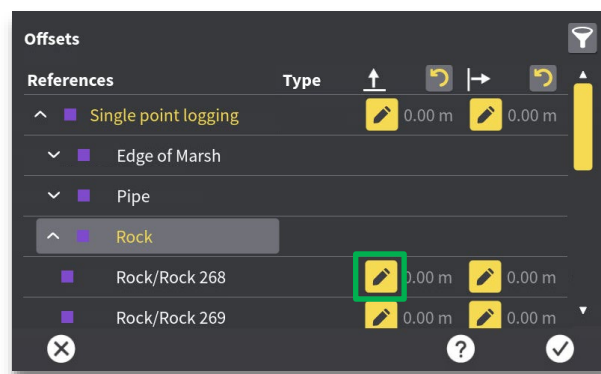

Step 3: Press the “Edit” button next to a reference to set an offset (height offset for point number 268 highlighted here).

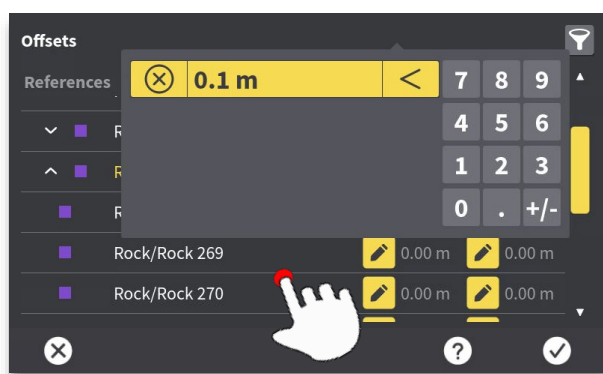

Step 4: Use the keypad to input a value and press anywhere outside the keypad to confirm.

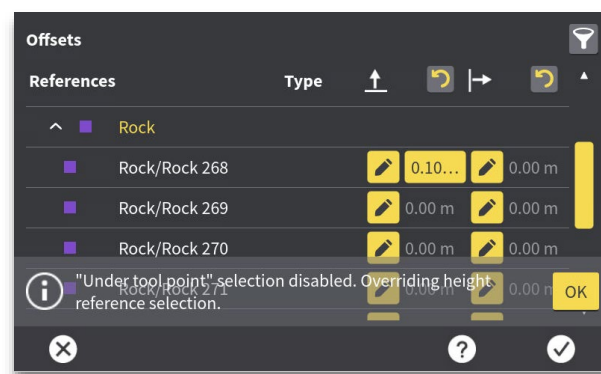

- A confirmation message is shown briefly (no need to acknowledge this message).

Workflow 04: Offset individual references (continued)

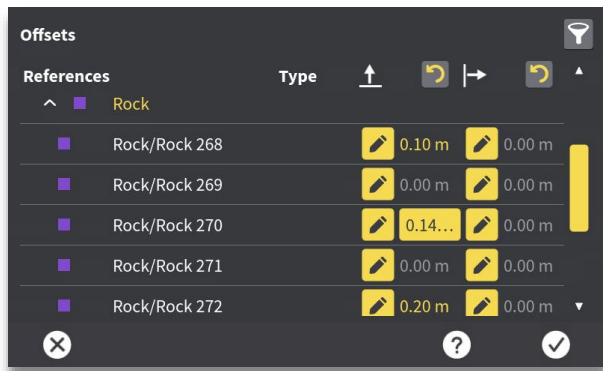

- The currently active offset is highlighted in a yellow box, whereas other offsets are written in yellow text.

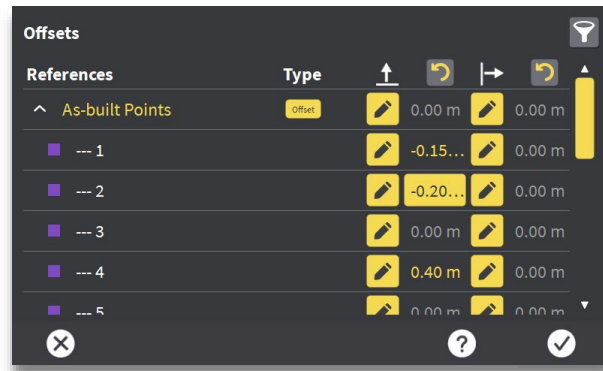

- The "revert" buttons at the top can be pressed to remove offset values for all references. Press check mark icon (OK).

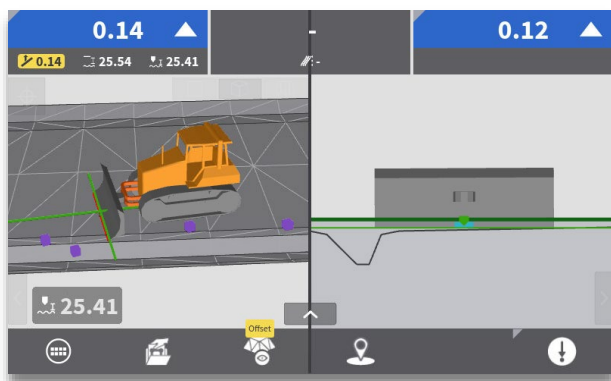

- Cut/fill values will be shown, providing guidance to new height offset. Original grade will still be shown in cross-section with applied offset.

Workflow 05: Enter temporary mast height

When mounting a prism on the mast you can increase the mast height above the cabin, so the cabin does not block the line of sight when using TPS. When using a single mast setup, it is preferably to use the centre mast if available. This workflow describes how to adjust the mast height and where to enter the offset values in MC1.

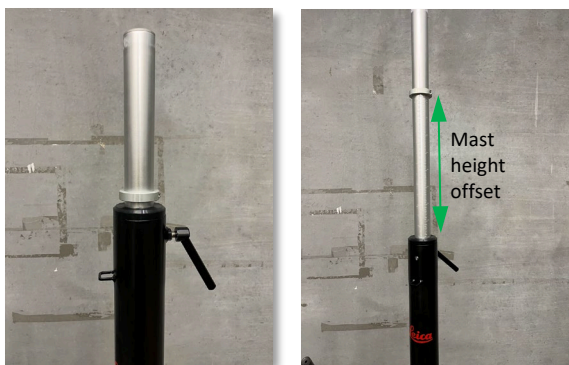

Step 1: Adjust the height of your mast.

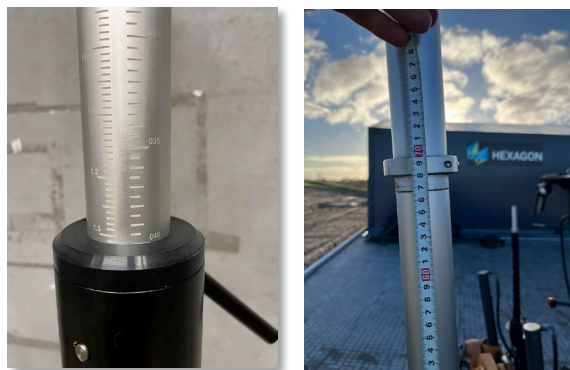

Step 2: Read the offset height directly on the mast or measure with a ruler. Note down the measurement.

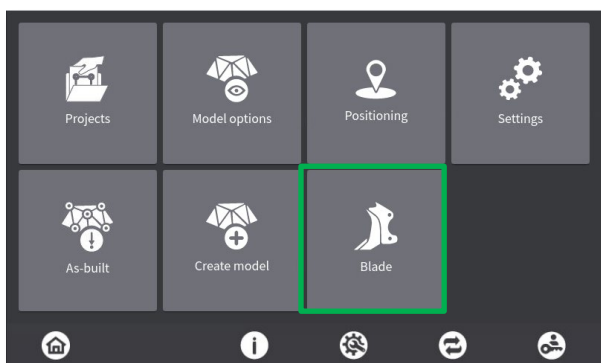

Step 3: Press "Blade" in the main menu.

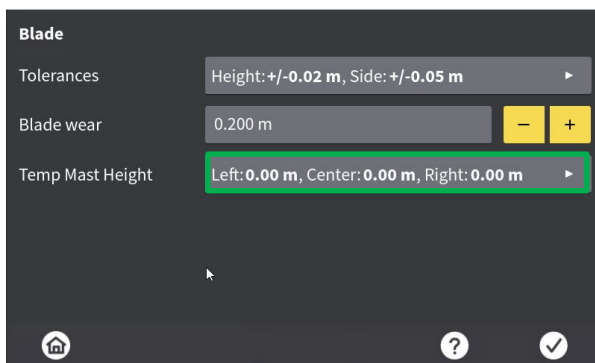

Step 4: Press the temp mast height menu. If offset values are entered, you can see them here. It is not mandatory to mount or enter offset values for all three masts.



Step 5: Enter the offset values measured in step 2 for the relevant mast. Leave the value 0.000 m for any masts you have not raised. Press the tick mark two times to return to the main menu. Return to this menu, when you lower your mast and change the offset value back to 0.000 m.

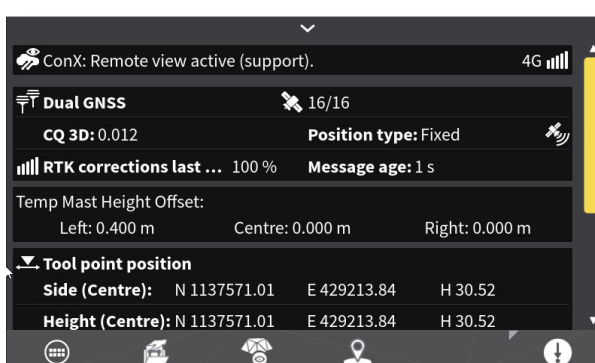

Step 6: Verify the entered off set values by opening the run screen pull up menu. We recommend verifying the tool point position against a known point of reference.

Workflow 06: Change "height tool point"

The height tool point defines where MC1 looks for elevation guidance, when a height "reference" is selected.

The "up" and "down" hard keys on the MCP80 panel toggle active height tool point.

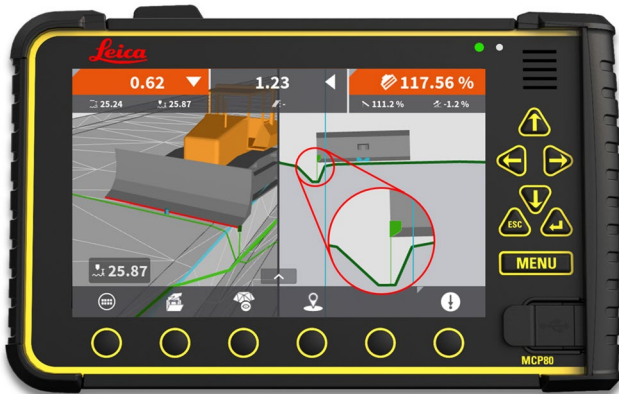

- Height tool points are represented by a "green" icon on the blade (Left height tool point is shown).

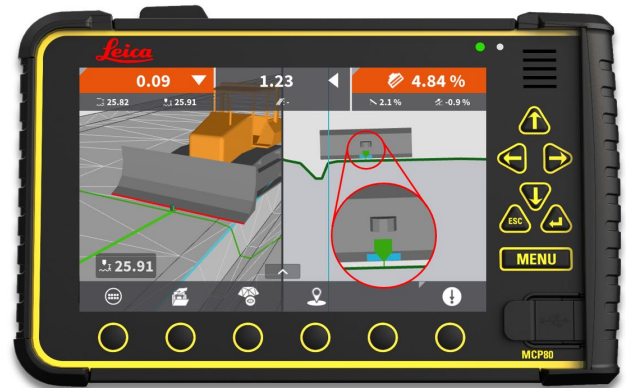

Step 1: Press "up" hard key to toggle height tool point to middle position.



Step 2: Press "up" hard key to toggle height tool point to right tip position.

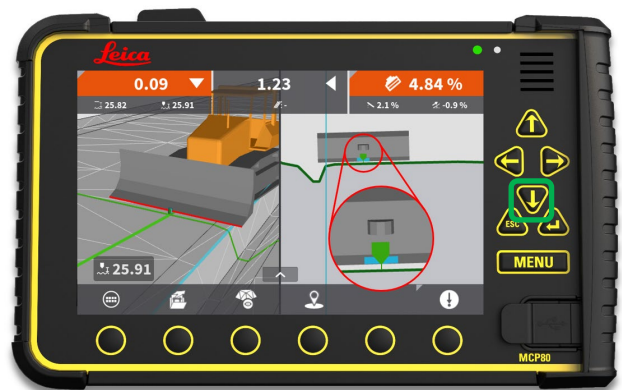

Step 3: Press "down" hard key to toggle height tool point in opposite direction.

Workflow 07: Change "side tool point"

The side tool point defines where MC1 looks for horizontal guidance, when a side "reference" is selected.

The "left" and "right" hard keys on the MCP80 panel toggle active side tool point.

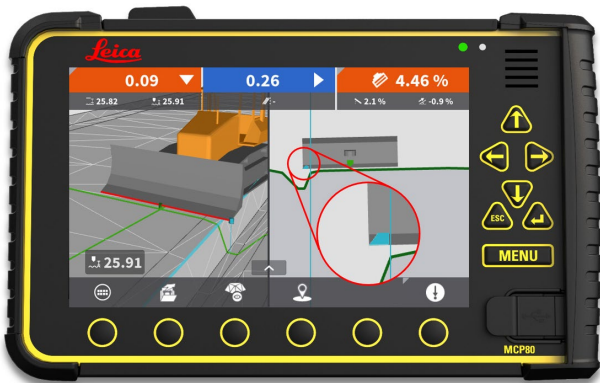

- Side tool points are represented by a "teal" icon on the blade (Left side tool point is shown).

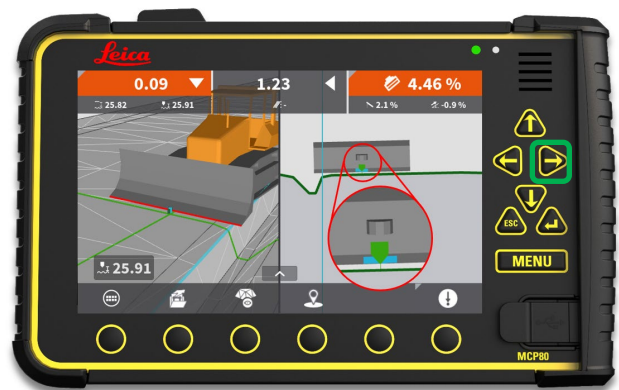

Step 1: Press "right" hard key to toggle side tool point to middle position.

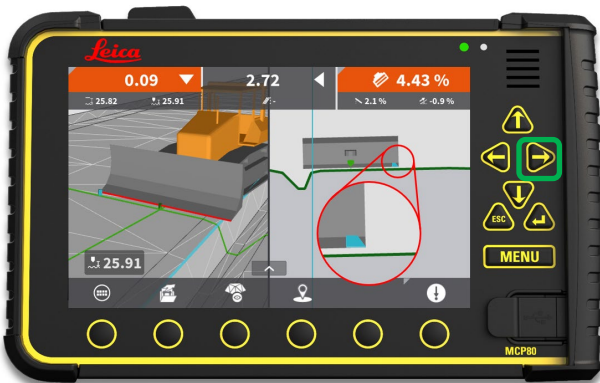

Step 2: Press "right" hard key to toggle side tool point to right tip position.

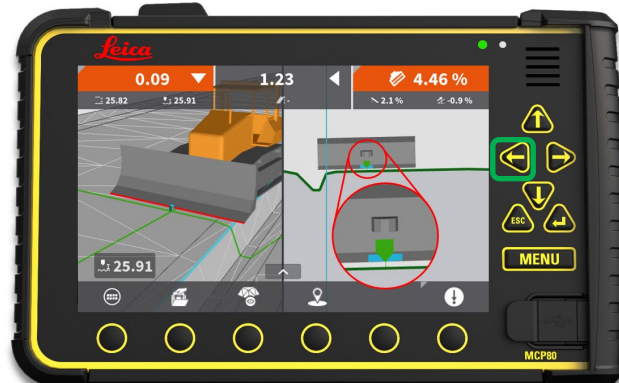

Step 3: Press "left" hard key to toggle side tool point in opposite direction.

Workflow 08: Select and use "height reference"

From the run screen, you can select and use different parts of your model as "height reference". The "height tool point" defines where MC1 looks at the model for elevation guidance. Understanding how this works is useful in different grading applications where you might need to overhang one part of your design to cut another. See [Workflow 09](#) for how to select and use a "side reference".

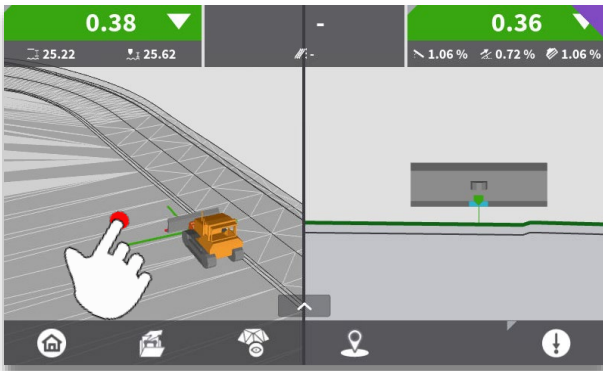

Step 1: Press and hold on plan view to see the "References" menu.

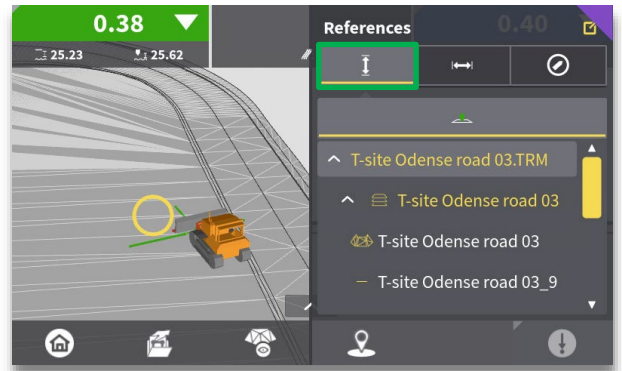

Step 2: Press  icon to view height references (if not already highlighted).

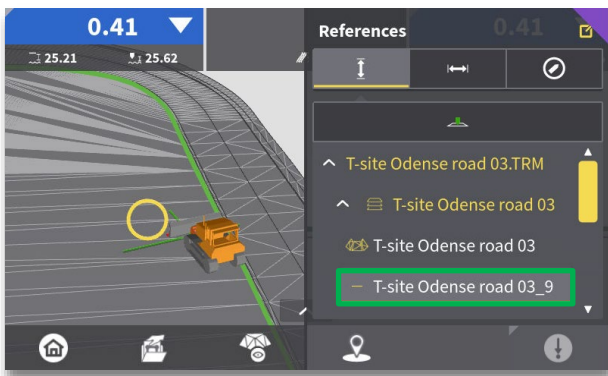

Step 3: Select the desired height reference (line "rightside" shown here). The line closest to selected point is listed at the top.



- A confirmation message is shown briefly (no need to acknowledge this message).

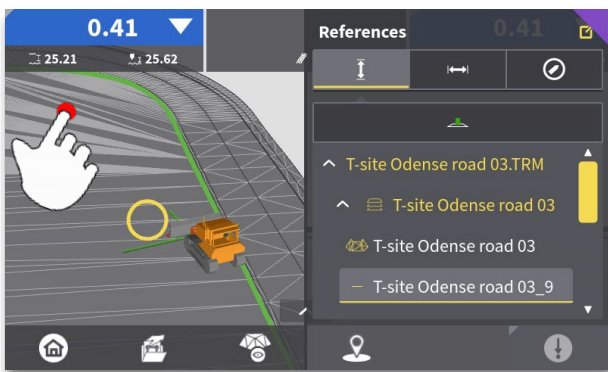

Step 4: Tap anywhere in the plan view to exit the "References" menu.



- The new surface will be represented by a bold green line. Cut/fill will be provided to this reference and design cross-slope and long slope will update to reflect the height reference selected.

Workflow 08: Select and use a height reference (continued)

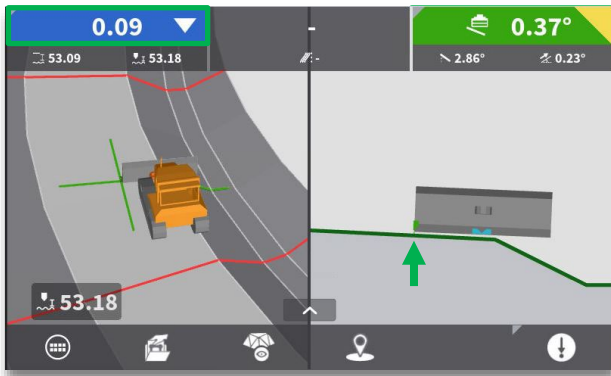

- Cut/fill and slope values are based on the surface below current height tool point (Left height tool point shown).

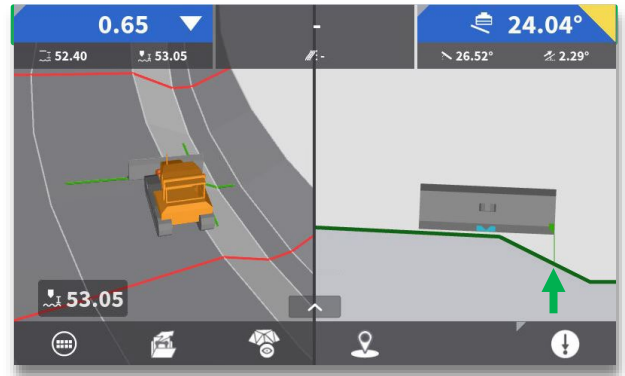

- When design slope changes under current height tool point, cut/fill and slope values also change (Right height tool point shown).

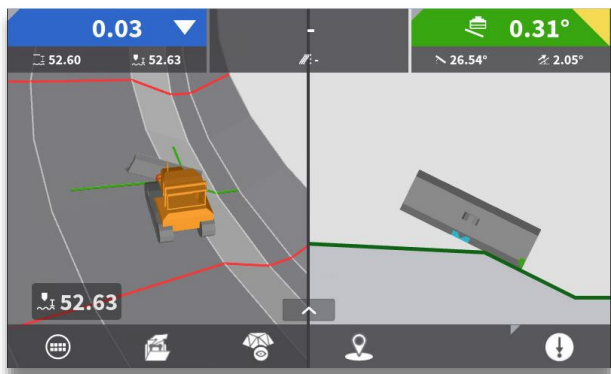

- In this picture the blade is very close to match the slope value and height under "height tool point". However not an ideal work setup for the machine since most of the blade is on a different slope.

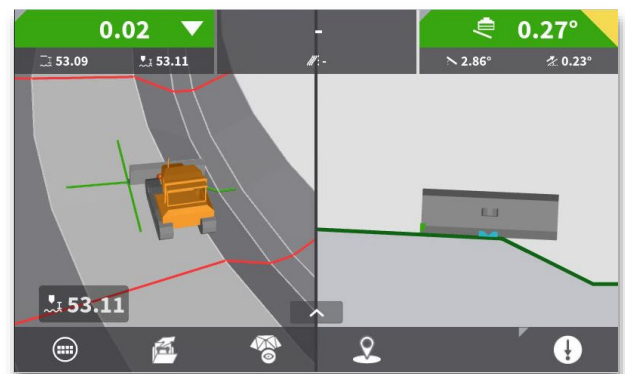

- Blade shown in correct position to grade surface under current height tool point.

Workflow 09: Select and use "side reference"

From the run screen, you can select and use different parts of your model as side reference. The side tool point defines where MC1 looks at the model for horizontal guidance. Select a point or line, and you will see a navigation bar at the top of the run screen. This navigation bar will guide you to the selected reference, based on your selected side tool point. See [Workflow 08](#) for how to select and use "height reference".

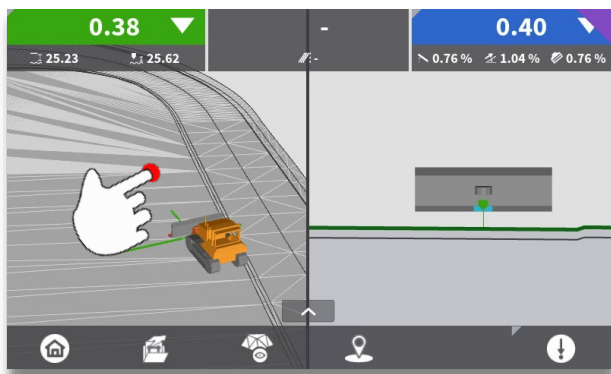

Step 1: Press and hold on plan view to see the "References" menu.

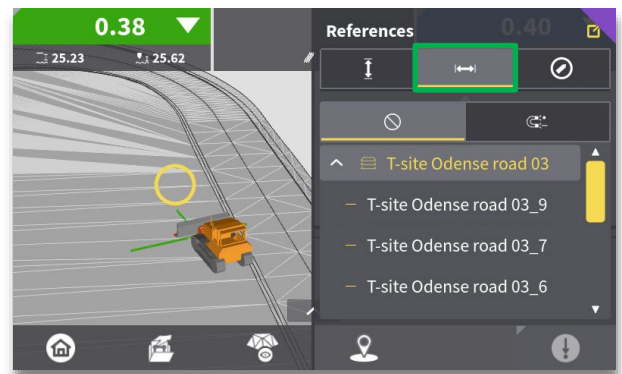

Step 2: Press  icon to view side references.

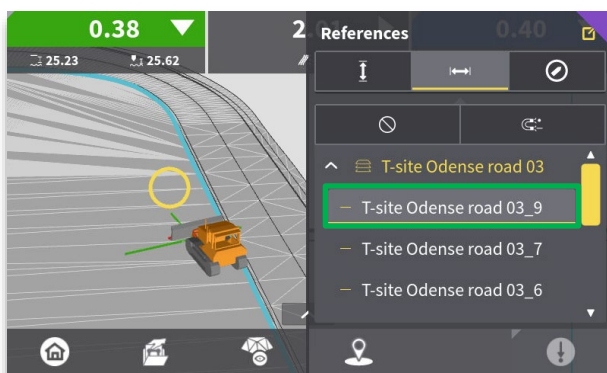

Step 3: Select desired line reference (line "rightside" shown here). The line closest to selected point is listed at the top.

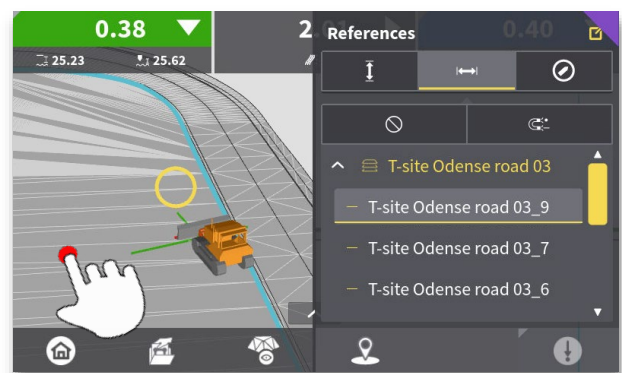

Step 4: Tap anywhere in the plan view to exit the "References" menu.

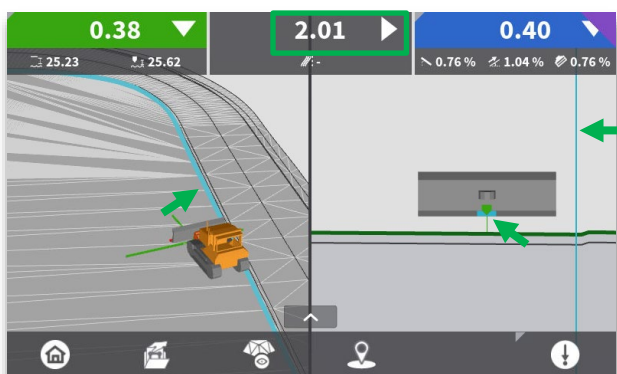

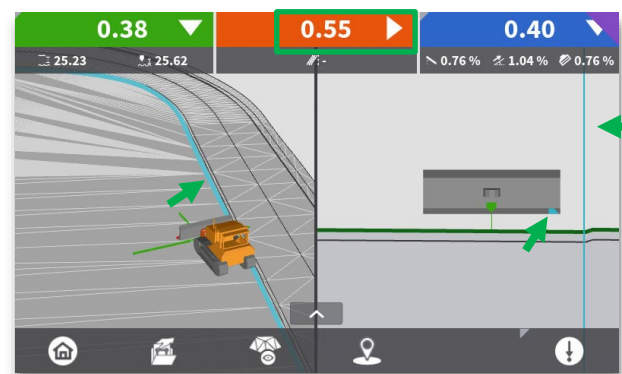

- The offset distance, from current side tool point to selected line reference, is shown at top centre of the screen. A teal line represents selected line in run screen.

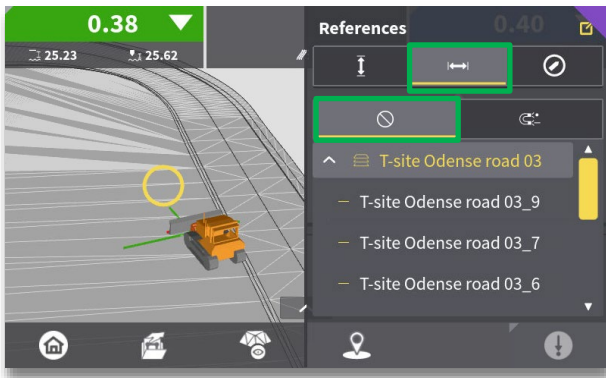

- Press "left/right" hard key to toggle current tool point. Notice the offset distance changes relative to this point.

Workflow 09: Select and use "side reference" (continued)



- To clear the side reference, press and hold on run screen, press  icon and select "None" to clear the side reference line.

Workflow 10: Daily machine check-in

An ideal control point, used for machine check-in, is positioned in an area that will not be disturbed for the duration of the project. The location should allow for the machine to be level in cross slope, and the blade should be level with the tracks. Use of a spotter on the ground is recommended to position the blade precisely.

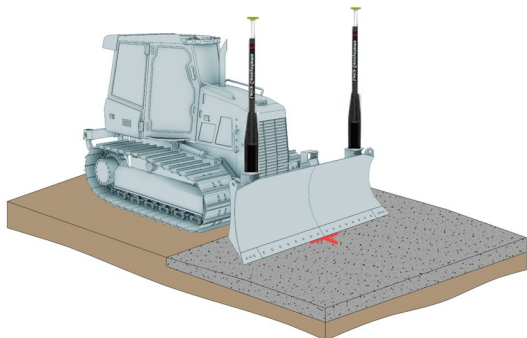

Step 1: Position centre of blade at control Point.

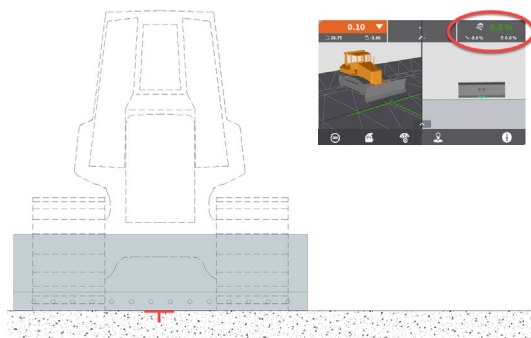

Step 2: Ensure blade is level with tracks, and that slope values are 0%.

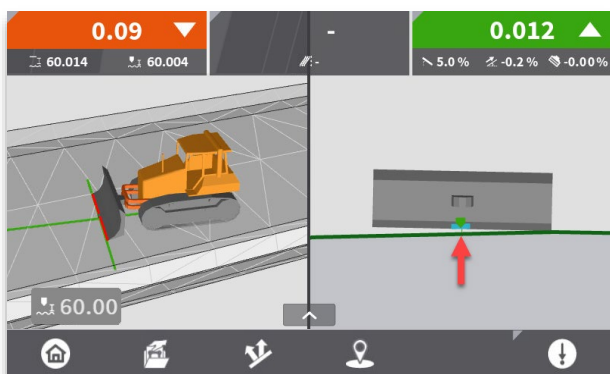

Step 3: Use "up/down" and "left, right" keys to place both "height" and "side" tool points at centre of blade and select "iCON" info bar.

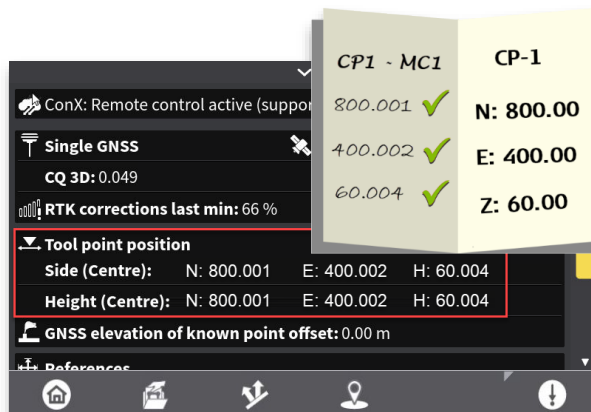

Step 4: Compare tool point position to CP coordinates.

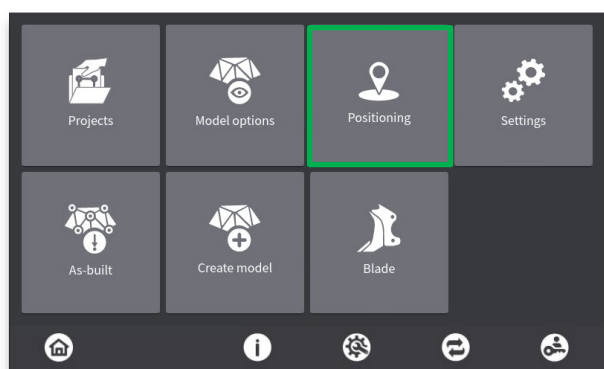

Step 5: If necessary, use the feature "GNSS elevation of known point" from "Main menu > Positioning".

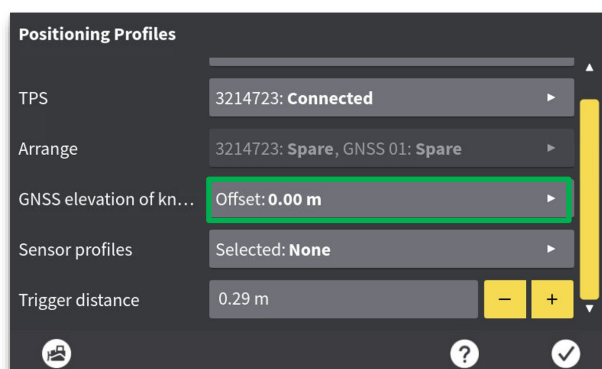

Step 6: If your elevation offset is more than 10cm (.328 feet), please call your machine tech for assistance.

Workflow 11: Adjust blade wear

Check for blade wear regularly. The cutting edge of your machine is designed to be replaceable, and the rate in which it wears depends upon the material it is working with. Incorrect measurement of blade wear can result in incorrect guidance. If the blade wear is uneven, measure a few spots along the cutting edge to find an average, or find the most representative place for a single measurement, avoiding the outer 0.5m of the blade.

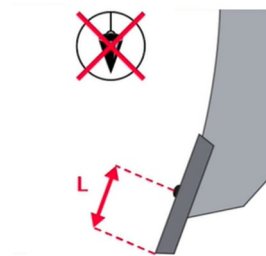
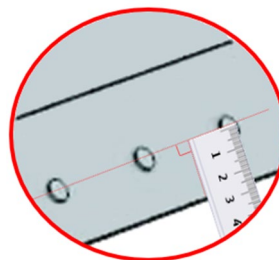
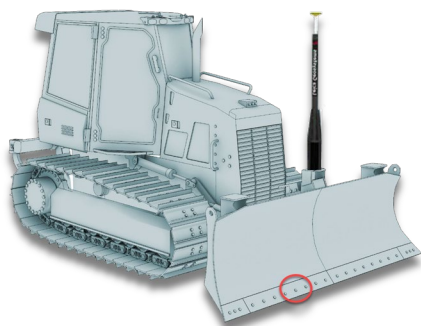

Step 1: Select a representative area of the cutting edge to measure blade wear (Avoid the outer .05m of the blade).

Step 2: Measure flat against surface of cutting edge to centre of bolt holes. This value represents your current blade wear.

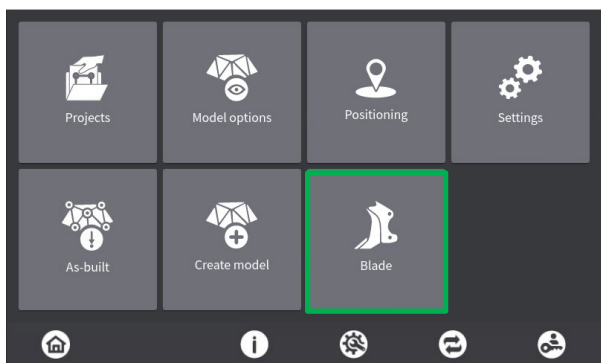

Step 3: Select "Blade" menu.

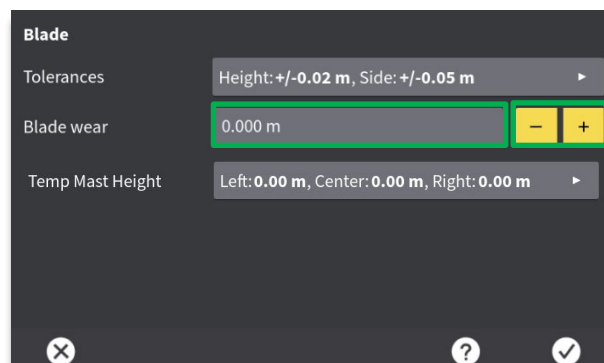

Step 4: Use + or - keys to increment blade wear value, or select the number to input manually.

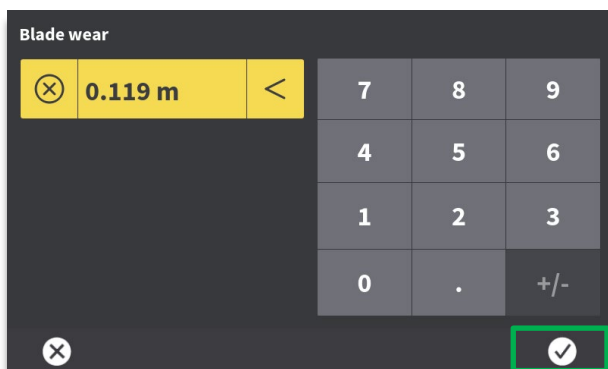

Step 5: Use keypad to enter blade wear value manually. Press "OK" to accept.

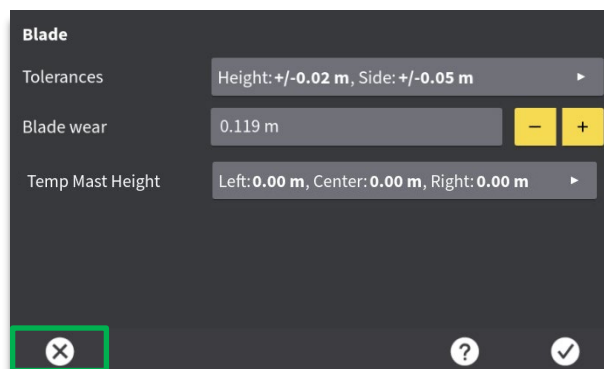

Step 6: Press "X" to exit to return to run screen.

Workflow 12: Activate auto mode

If your machine is equipped with automatic functionality you can activate automatic blade control, when the blade is within a specified distance from the design. When in "auto", the blade will attempt to achieve 0.00 cut/fill. Please ensure your machine is pushing material when "auto" is engaged.

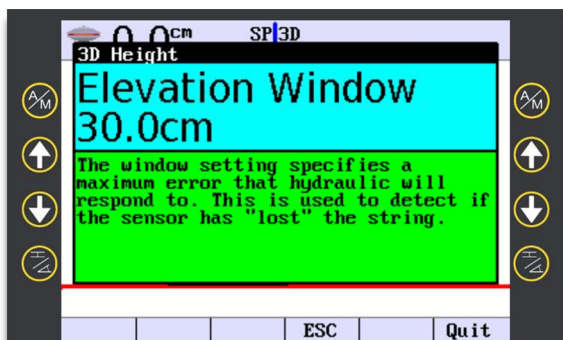

- "3D Height Elevation Window" is set in the 2D UI > Configure > Adjust > Right 3x. If outside this window Auto will not engage. Suggested value is 30cm (0.98') typically set by technician.

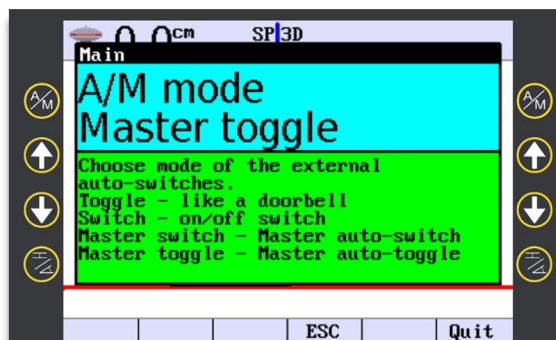

- There are multiple Auto/Manual mode Toggle functions to select from, typically set by technician.

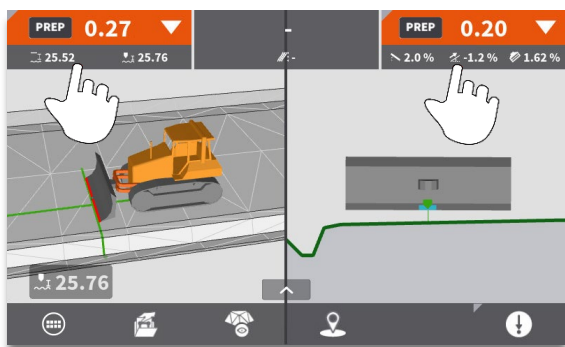

Step 1: Press and hold cut/fill on each side to get PREP to appear (This step is not necessary if set to A/M Mode: Toggle).



Step 2: Press installed "auto" button, to engage automatic control of the blade.

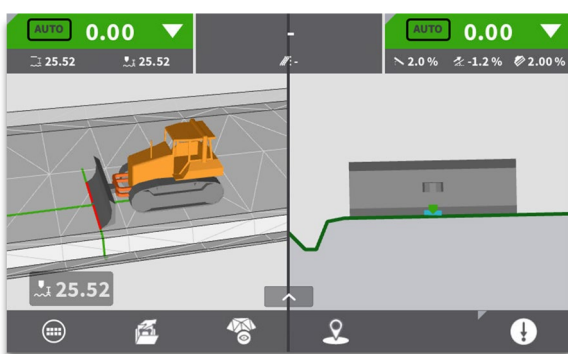

- When "auto" is engaged, top left and right guidance bars show "AUTO" in green, and blade attempts to achieve 0.00 cut/fill.

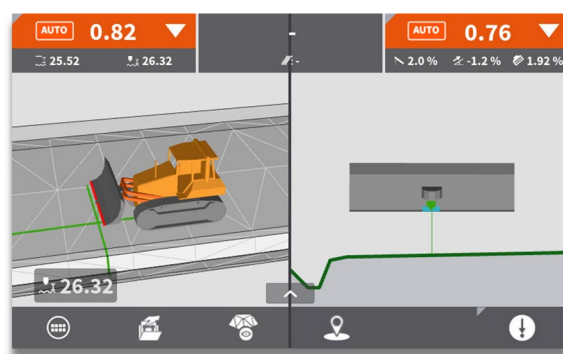

- If the blade is raised outside of the configured elevation window, the system will go into red (inactive auto)

Workflow 13: Create point logs

You can log points on your design, from the run screen. Apply a user defined point log, or select from a predefined point log. MC1 automatically sends stored points to ConX (If connected to ConX).



Step 1: Press “Log point” button to quickly log a point.

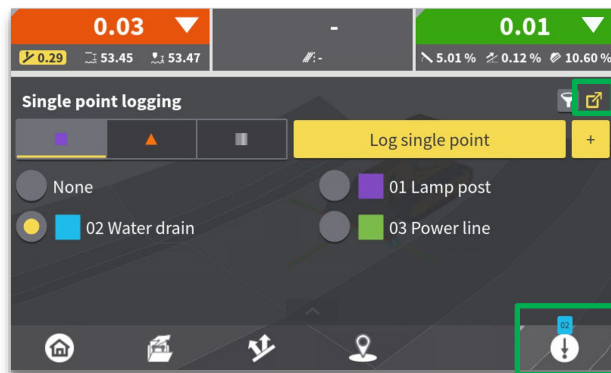

Step 2: Press and hold “Log point” button. Select a point code from available point code list and press “Log point” button to log a point with that point code. For more options press quick access button in top right corner.

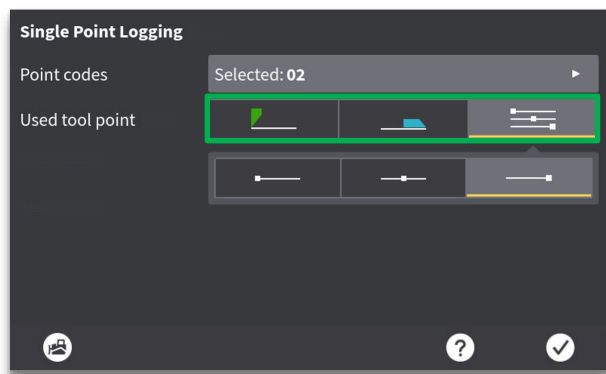

Step 3: Choose which tool point to use when logging a point (Current height tool point, current side tool point or specific tool point not used for height or side references). Press dozer icon to return to run screen.

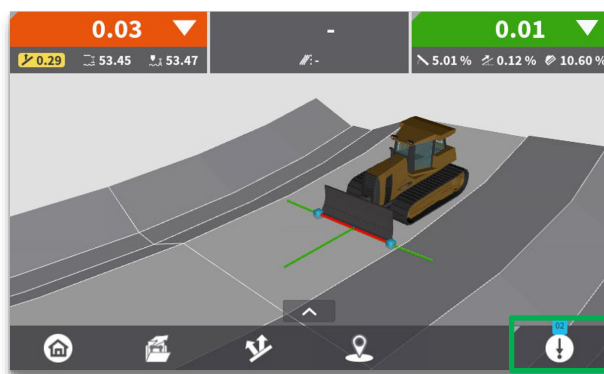

Step 4: Press “Log point” button to log a point.

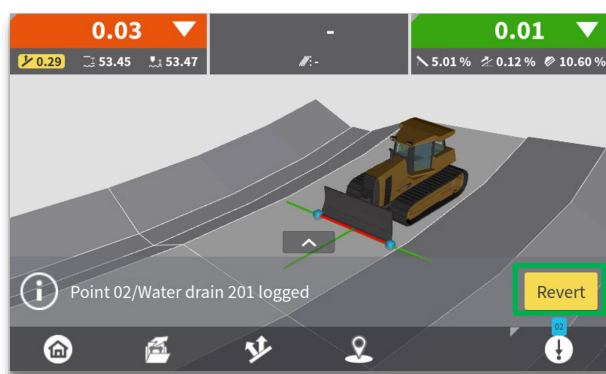

Step 5: If necessary, press “Revert” to remove previously logged point.

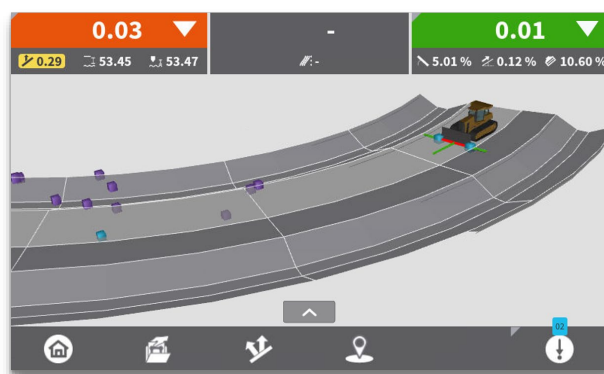

- If configured, previously stored points will appear in the plan view as coloured dots.

Workflow 14: Synchronize files

Files can be synchronized to ConX or a USB key. This way you can send or receive files between machine and office.

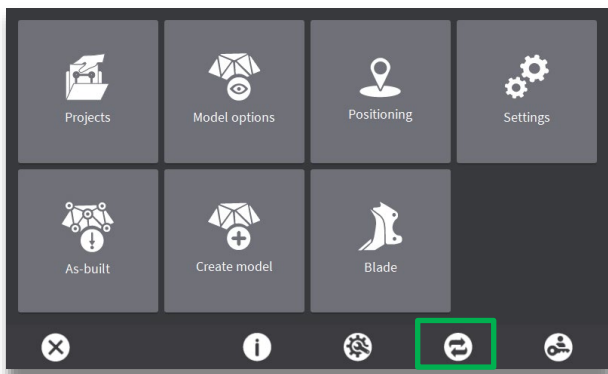

Step 1: Press the synchronization button.

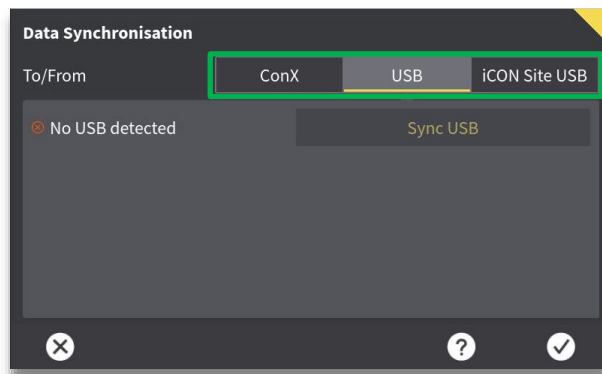

- Selection of possible synchronisation methods. USB is only selectable when inserted.

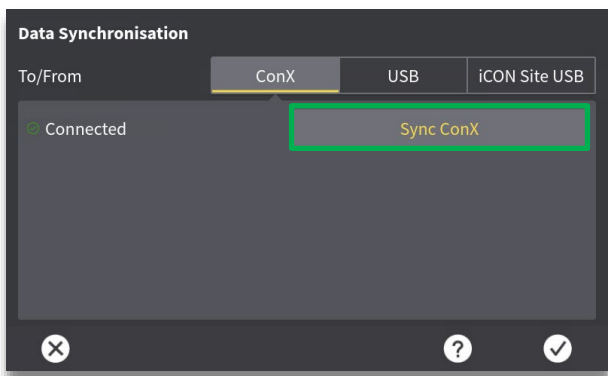

Step 2: Select desired synchronisation method. ConX is connected and therefore available for Sync.

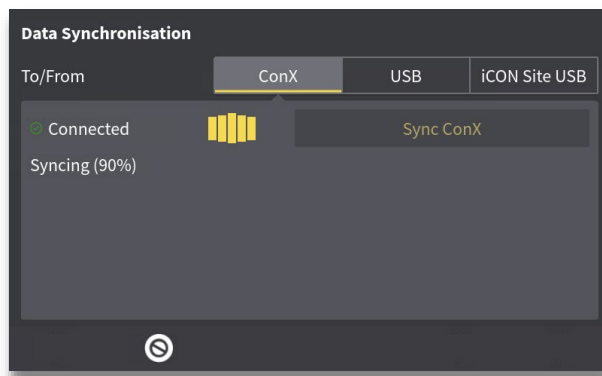

- Files will be synchronized both directions. Progress will be indicated on screen.

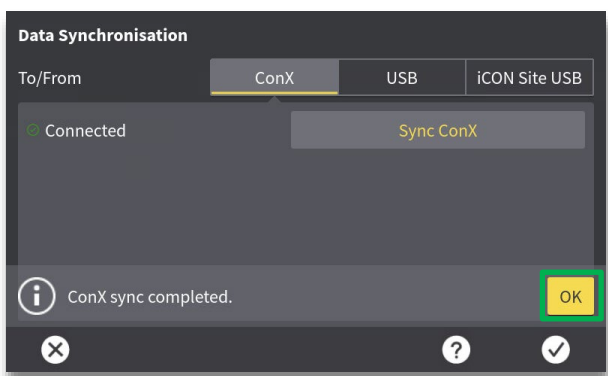

- It is not necessary to acknowledge the successful synchronisation.

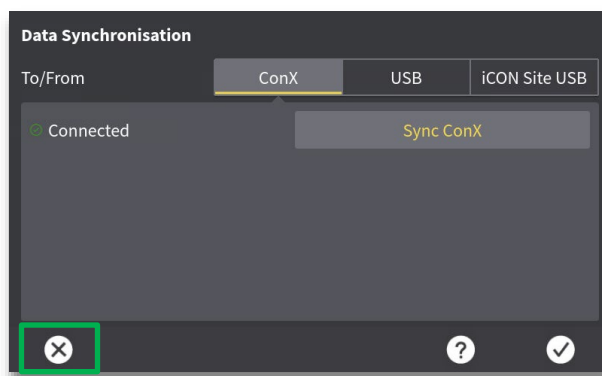

Step 3: Press X to return to run-screen.

5. Appendix: List of "how to" videos

Use this link <https://leicageosystems.how/usingMC1dozergrader> or the QR code below to access a wide selection of "how to" videos that will help you get the most out of your work with MC1 for dozer:



The following is a selection of the currently available videos:

- Using dozer and grader run screens.
- How to set up 3D sensor profiles.
- How to select a predefined coordinate system.
- Engage a project.
- How to engage with surface models.
- How to engage with string line models.
- Multiple surfaces model.
- Select a stationing line.
- Run screen settings.
- Using hold slope – an advanced feature.
- Auto point logging.
- Calibrate your cross slope sensor.
- Adjust for blade wear.
- Setting tolerances and beep settings.
- ...many more videos will be added.